



PRODUCT CATALOGUE



# CONTENT

## PRODUCTS

<b>INTRODUCTION</b>	4
<b>LED SERIES</b>	
SCORPIUS PRO 445	10
CENTAURUS	12
SCORPIUS	18
ANTARES	24
VIRGO	28
SPICA	34
CANIS	40
CAPELLA	44
<b>GO SERIES</b>	
SCORPIUS GO	50
CANIS GO	51
ANTARES GO	52
<b>KL SERIES</b>	54
<b>SPECIAL LIGHTS</b>	
GEMINI	62
PICTOR	66
TAURUS	68
DORADO	70
VELA	72
SCULPTOR	74
<b>HEADLIGHTS</b>	76
<b>HALOGEN WORK LIGHTS</b>	77
<b>HALOGEN INDICATOR LIGHTS</b>	80
<b>HALOGEN FLUSHMOUNT</b>	81
<b>HID WORK LIGHTS</b>	83
<b>WARRANTY &amp; ABBREVIATIONS</b>	86

# LIGHT EXPERTISE FROM

We are embedded in an ideal framework for the building of key expertise in developing lighting solutions for heavy-duty equipment. Coming from the Nordic countries, with our, at times, extreme weather conditions and climate, we understand the importance of optimal lighting. Productive collaboration with our partners in different branches of industry and continuous strategic investments in our own R&D department, laboratories, and the latest in simulation software has made us experts in lighting technology. We are ISO 9001 and ISO 14001 certified and our quality management system covers all key processes.

Today, we can claim to be the world's best producer of lights for heavy-duty vehicles. We develop, design, manufacture, and test all of our light series in our own factory in Finland. This way we ensure that every part of the process is fine-tuned to perfection. We take pride in the fact that we are not newcomers,

but have been excelling in our field for decades.

The use of NORDIC LIGHTS® work lights on your heavy-duty equipment is a brilliant choice. You will get superior durability, low maintenance, and the best available technology backed by extensive testing. It is important to us to offer the right lighting solution to each customer. The light is optimized for the specific equipment or use by different combinations of light patterns, brackets, dampeners, and cable connectors. You can choose your LED work light from our extensive product range, or we can customize it for you.

In the introduction to our product range found in this brochure you will find the product's key facts, such as technical data and light patterns. If you would like to find out more about the What, How, and Why, please visit [nordiclights.com](http://nordiclights.com).

# OM FINLAND



# THIS IS



# HOW WE ROLL



## Making Outstanding Lights for Heavy-Duty Vehicles

We make sure your product is truly ready for heavy-duty use. We will help you improve light distribution, efficiency, and safety on the worksite. All our lights are premium products, sturdy and reliable. They are put through extensive testing before passing inspection. These tests include lumen output and light distribution, vibration and shock, dust and humidity, heat and cold exposure, thermal cycling, thermal protection, electromagnetic compatibility, full functionality, abnormal conditions, chemical resistance, and usability. Our products are valued for their even light distribution, low PPM, and zero emissions in many cases.

## XTR The Unbreakable Master

**WE AIM FOR PERFECTION.** This time, it meant creating something unbreakable. May we introduce our XTR series; premium lights with an outstanding lifespan and light output up to 7200 lumens. The work lights in the XTR series come equipped with our revolutionary QUAKE dampening system designed to withstand the harshest conditions. With a strength capacity of 20 Grms, the XTR takes protection against shock and vibration to the next level.

## PRO The Heavy-Duty Champion

**WE GIVE YOU OPTIONS.** For the products in the PRO series we offer a wide range of light patterns and possibilities for customization. The work lights in our PRO series are equipped with die-cast brackets and a dampening system with a strength capacity of up to 15.3 Grms. With a light output of up to 4200 lumens, the upmarket products in our PRO series are tough to beat.

## GO The Step-It-Up Series

**WE BELIEVE IN SIMPLICITY.** The GO series is aimed at those customers who are completely new to our products or would like to enhance their lighting standard from halogen to LED. In this series, we designed a variety of standard models with a long lifespan and low maintenance. Easy to use, the work lights in the GO series have a light output of between 1000 and 2300 lumens, and a dampening strength capacity of 8 Grms.

## KL The Affordable One

**WE CREATE SENSIBLE SOLUTIONS.** The work lights in our KL series are an excellent choice when you're looking for a cost-effective alternative for your heavy-duty equipment. This go-to product line is developed with both new and existing customers in mind, optimizing basic design and low-maintenance. The KL lights withstand vibration up to 8 Grms and their light output ranges from 300 to 2000 lumens.







# SCORPIUS PRO 445

## MEASUREMENTS

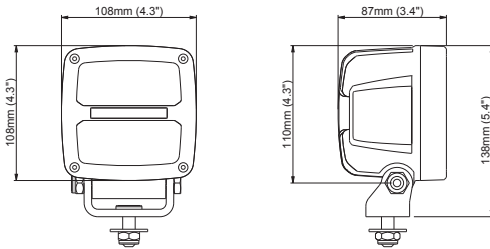

# NEW!

# THE CONQUEROR



The Scorpius PRO 445 is the newest addition to our product range. This is the next-generation Scorpius work light with improved design, the very latest in LED technology, and improved color rendering. For your safety, this light has superior electromagnetic compatibility. The Scorpius PRO 445 offers better mechanical properties, is lighter in weight, and has a new lens material with exceptional heat tolerance. It has an asymmetric wide flood feature and a light output of 4400 lumens.

## TECHNICAL SPECIFICATIONS

## SCORPIUS PRO 445

Theoretical / Operational Lumens Output:	7000 lm / 4400 lm
Colour Temperature:	5000 K
Nominal / Input Voltage DC:	12, 24 VDC / 9-32 VDC
Power Consumption:	50 W
Nominal Current:	4.2 A @ 12 V / 2.1 A @ 24 V
Mount:	M10 Bolt / Pedestal
Connector:	Built-in Deutsch DT-2 (2-pin)
EMC:	CISPR 25 Class 5, ISO 13766, ISO 14982-2, ISO 11452-2, ISO 7637-2, EN 61000-4-2
Electronics:	Integrated
Shock:	60G
Vibration:	15.3 Grms 24-2000 Hz
Lens:	Grilamid® (registered trademark of EMS-GRIVORY)
Body:	Aluminium (K-Alloy)
IP Rating:	IP68, IP6K9K
Weight:	1,0 kg
Operating Temperatures:	-40°C... +85°C (Overheat protected)



## LIGHT PATTERNS

SCORPIUS PRO 445, 4400lm  
High beam

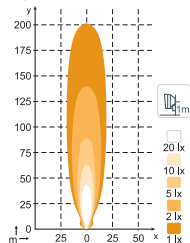

SCORPIUS PRO 445, 4400lm  
Flood

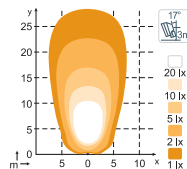

SCORPIUS PRO 445, 4400lm  
Wide Flood (Symmetric)

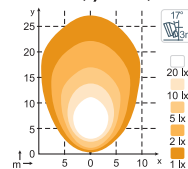

SCORPIUS PRO 445, 4400lm  
Wide Flood (Asymmetric)

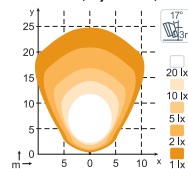

# CENTAURUS

## MEASUREMENTS

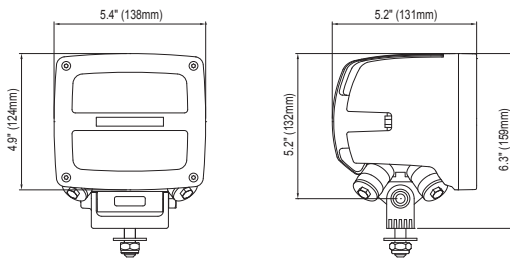

# THE DIAMOND

The Centaurus is our masterpiece. This product is primarily used in the mining industry and is particularly useful for bucket-wheel excavators, draglines, highwall miners, hydraulics, surface miners, and wheel dozers. The Centaurus product family has a square form factor and utilizes our groundbreaking innovation, the QUAKE dampening system, and has an output of up to 7200 lumens.



OND





## TECHNICAL SPECIFICATIONS

## CENTAURUS LED N4601 QD

Theoretical / Operational Lumens Output:	11500lm / 7200lm
Colour Temperature:	5700K
Nominal / Input Voltage DC:	18-32V
Power Consumption:	85W
Nominal Current:	3.5A
Mount:	Single Bolt M10
Connector:	Built-in Deutsch DT-2 (2-pin)
EMC:	CISPR 25 Class 3, ISO 13766, ISO 14982, ISO 7637-2
Electronics:	Integrated
Shock:	60G
Vibration:	15.3Grms 24-2000Hz, 4.65Grms 12-2000Hz
IP Rating:	IP68, IP6K9K, SAE J1455
Weight:	2.5kg
Operating Temperatures:	-40°C... +85°C (Overheat protected)

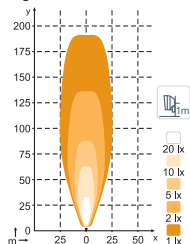
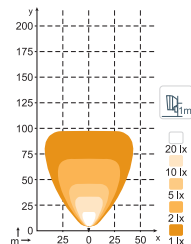
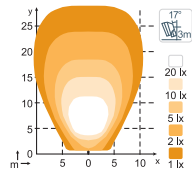
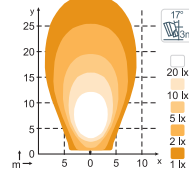

## LIGHT PATTERNS

N4601 QD 7200lm  
High BeamN4601 QD 7200lm  
Low BeamN4601 QD 7200lm  
Wide FloodN4601 QD 7200lm  
Flood



# SCORPIUS

## MEASUREMENTS

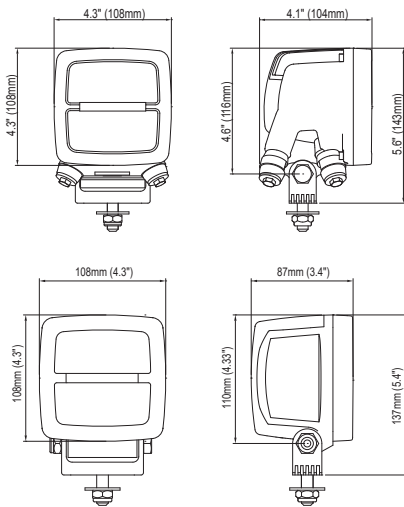

# IN A LEAGU

The Scorpius product series is the most popular in our collection and sees use in many industries, including mining, construction, forestry, trucking, emergency response, agriculture, and material handling. It has an asymmetric wide flood feature, making it the best light pattern you will find on the market, particularly suitable for large, open spaces. This product family has a square form factor, and an output ranging between 2000 and 4200 lumens.





# E OF ITS OWN





TECHNICAL SPECIFICATIONS	SCORPIUS LED N4401 QD	SCORPIUS LED N4402
Theoretical / Operational Lumens Output:	6700 lm / 4200lm	6700lm / 4200 lm
Colour Temperature:	5700K	5700K
Nominal / Input Voltage DC:	12–24V / 9–32V	12–24V / 9–32V
Power Consumption:	50W	50W
Nominal Current:	24V=2.1A / 12V=4.2A	24V=2.1A / 12V=4.2A
Mount:	Single Bolt M10	Single Bolt M10
Connector:	Built-in Deutsch DT-2 (2-pin)	Built-in Deutsch DT-2 (2-pin)
EMC:	CISPR 25 Class 3	CISPR 25 Class 3
Electronics:	Integrated	Integrated
Shock:	60G	60G
Vibration:	20Grms 24–2000Hz / 4.65Grms 12–2000Hz	15.3Grms 24–2000Hz
IP Rating:	IP68 / IP6K9K / SAE J1455	IP68 / IP6K9K / SAE J1455
Weight:	1.6kg	1.1kg
Operating Temperatures:	-40°C... +85°C (Overheat protected)	-40°C... +85°C (Overheat protected)

▽ LIGHT PATTERNS

N4401 QD, N4402 4200lm  
High Beam

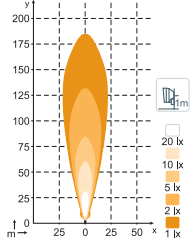

N4401 QD, N4402 4200lm  
Low Beam

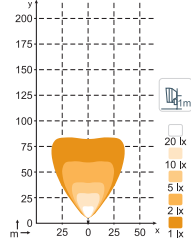

N4401 QD, N4402 4200lm  
Wide Flood

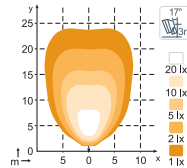

N4401 QD, N4402 4200lm  
Flood

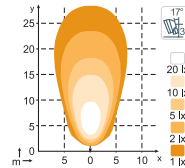

N4401 QD, N4402 3360lm  
Diffused

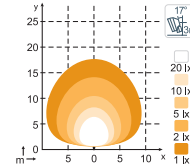



## TECHNICAL SPECIFICATIONS

## SCORPIUS LED N4403 QD

## SCORPIUS LED N4404

Theoretical / Operational Lumens Output:	4800lm / 3000lm	4800lm / 3000lm
Colour Temperature:	5700K	5700K
Nominal / Input Voltage DC:	12–24V / 9–32V	12–24V / 9–32V
Power Consumption:	45W	45W
Nominal Current:	24V=1.9A / 12V=3.8A	24V=1.9A / 12V=3.4A
Mount:	Single Bolt M10	Single Bolt M10
Connector:	Built-in Deutsch DT-2 (2-pin)	Built-in Deutsch DT-2 (2-pin)
EMC:	CISPR 25 Class 3	CISPR 25 Class 3
Electronics:	Integrated	Integrated
Shock:	60G	60G
Vibration:	20Grms 24–2000Hz / 4.65Grms 12–2000Hz	15.3Grms 24–2000Hz
IP Rating:	IP68 / IP6K9K / SAE J1455	IP68 / IP6K9K / SAE J1455
Weight:	1.6kg	1.1kg
Operating Temperatures:	-40°C... +85°C (Overheat protected)	-40°C... +85°C (Overheat protected)

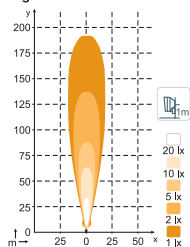
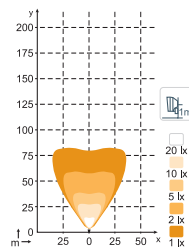
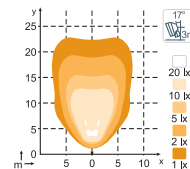
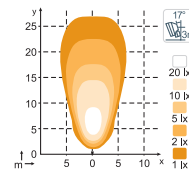
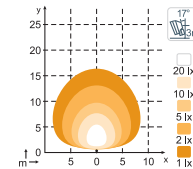

## LIGHT PATTERNS

N4403 QD, N4404 3000lm  
High BeamN4403 QD, N4404 3000lm  
Low BeamN4403 QD, N4404 3000lm  
Wide FloodN4403 QD, N4404 3000lm  
FloodN4403 QD, N4404 2400lm  
Diffused



TECHNICAL SPECIFICATIONS	SCORPIUS LED N4405 QD	SCORPIUS LED N4406
Theoretical / Operational Lumens Output:	3400 lm / 2100lm	3400lm / 2100lm
Colour Temperature:	5700K	5700K
Nominal / Input Voltage DC:	12–24V / 9–32V	12–24V / 9–32V
Power Consumption:	35W	35W
Nominal Current:	24V=1.5A / 12V=3.0A	24V=1.5A / 12V=3.0A
Mount:	Single Bolt M10	Single Bolt M10
Connector:	Built-in Deutsch DT-2 (2-pin)	Built-in Deutsch DT-2 (2-pin)
EMC:	CISPR 25 Class 3	CISPR 25 Class 3
Electronics:	Integrated	Integrated
Shock:	60G	60G
Vibration:	20Grms 24–2000Hz / 4.65Grms 12–2000Hz	15.3Grms 24–2000Hz
IP Rating:	IP68 / IP6K9K / SAE J1455	IP68 / IP6K9K / SAE J1455
Weight:	1.6kg	1.1kg
Operating Temperatures:	-40°C... +85°C (Overheat protected)	-40°C... +85°C (Overheat protected)

▽ LIGHT PATTERNS

N4405 QD, N4406 2100lm High Beam

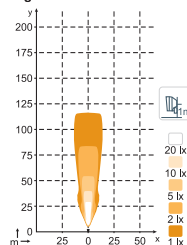

N4405 QD, N4406 2100lm Low Beam

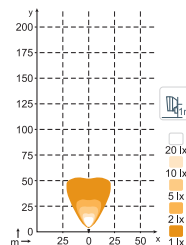

N4405 QD, N4406 2100lm Wide Flood

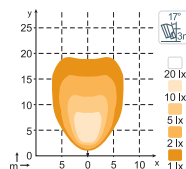

N4405 QD, N4406 2100lm Flood

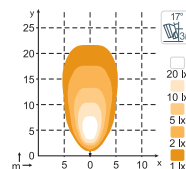

N4405 QD, N4406 1680lm Diffused

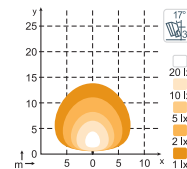



## TECHNICAL SPECIFICATIONS

## SCORPIUS LED N4407 QD

## SCORPIUS LED N4408

Theoretical / Operational Lumens Output:	3700 lm/2300lm	3700lm / 2300lm
Colour Temperature:	5700K	5700K
Nominal / Input Voltage DC:	12–24V / 9–32V	12–24V / 9–32V
Power Consumption:	40W	40W
Nominal Current:	24V=1.7A / 12V=3.4A	24V=1.7A / 12V=3.4A
Mount:	Single Bolt M10	Single Bolt M10
Connector:	Built-in Deutsch DT-2 (2-pin)	Built-in Deutsch DT-2 (2-pin)
EMC:	CISPR 25 Class 3	CISPR 25 Class 3
Electronics:	Integrated	Integrated
Shock:	60G	60G
Vibration:	20Grms 24–2000Hz / 4.65Grms 12–2000Hz	15.3Grms 24–2000Hz
IP Rating:	IP68 / IP6K9K / SAE J1455	IP68 / IP6K9K / SAE J1455
Weight:	1.6kg	1.1kg
Operating Temperatures:	-40°C... +85°C (Overheat protected)	-40°C... +85°C (Overheat protected)

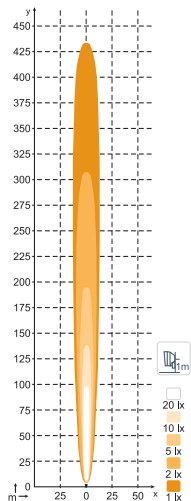
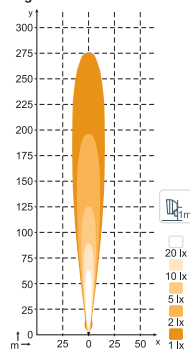
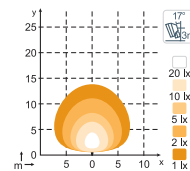

## LIGHT PATTERNS

N4407 QD, N4408 2300lm  
Pencil BeamN4407 QD, N4408 2300lm  
High BeamN4407 QD, N4408 1840lm  
Diffused



## TECHNICAL SPECIFICATIONS

## SCORPIUS LED N4409 QD

## SCORPIUS LED N4410

Theoretical / Operational Lumens Output:	3200 lm / 2000lm	3200lm / 2000 lm
Colour Temperature:	5700K	5700K
Nominal / Input Voltage DC:	12V, 24V / 9–16V, 18–32V	12V, 24V / 9–16V, 18–32V
Power Consumption:	40W	40W
Nominal Current:	24V=1.7A / 12V=3.4A	24V=1.7A / 12V=3.4A
Mount:	Single Bolt M10	Single Bolt M10
Connector:	Built-in Deutsch DT-2 (2-pin)	Built-in Deutsch DT-2 (2-pin)
EMC:	CISPR 25 Class 5	CISPR 25 Class 5
Electronics:	Integrated	Integrated
Shock:	60G	60G
Vibration:	20Grms 24–2000Hz / 4.65Grms 12–2000Hz	15.3Grms 24–2000Hz
IP Rating:	IP68 / IP6K9K / SAE J1455	IP68 / IP6K9K / SAE J1455
Weight:	1.6kg	1.1kg
Operating Temperatures:	-40°C... +85°C (Overheat protected)	-40°C... +85°C (Overheat protected)

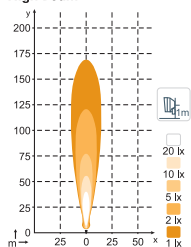
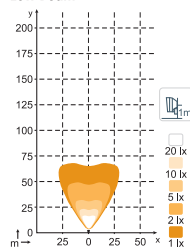
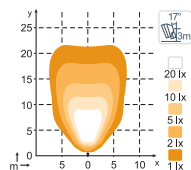
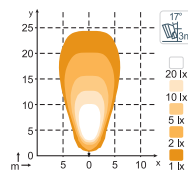
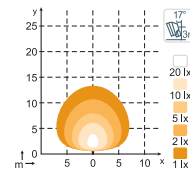

## LIGHT PATTERNS

N4409 QD, N4410 2000lm  
High BeamN4409 QD, N4410 2000lm  
Low BeamN4409 QD, N4410 2000lm  
Wide FloodN4409 QD, N4410 2000lm  
FloodN4409 QD, N4410 1600lm  
Diffused



# ANTARES

## MEASUREMENTS

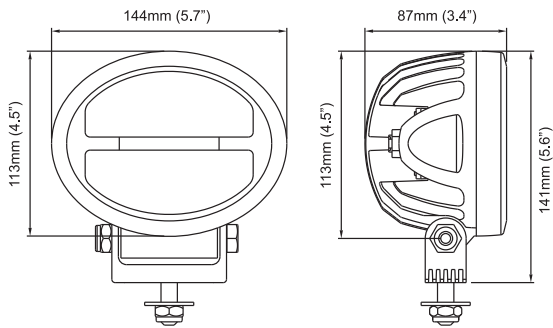

# THE COWB

The Antares is our series designed specifically for the agricultural industry. These heavy-duty lights suit bean, beet, potato and pea harvesters, combine and forage harvesters, crop sprayers, slurry tankers, and tractors. This product family has an oval form factor and pedestal mounting. The light output for this series ranges between 2000 and 4200 lumens.





OY





## TECHNICAL SPECIFICATIONS

### ANTARES LED N3301

### ANTARES LED N3302

<b>Theoretical / Operational Lumens Output:</b>	6700lm / 4200lm	4800lm / 3000lm
<b>Colour Temperature:</b>	5700K	5700K
<b>Nominal / Input Voltage DC:</b>	12-24V / 9-32V	12-24V / 9-32V
<b>Power Consumption:</b>	50W	45W
<b>Nominal Current:</b>	24V: 2.1A, 12V: 4.2A	24V: 1.9A, 12V: 3.8A
<b>Mount:</b>	Single Bolt M10	Single Bolt M10
<b>Connector:</b>	Built-in Deutsch DT-2 (2-pin)	Built-in Deutsch DT-2 (2-pin)
<b>EMC:</b>	CISPR 25 Class 3, ISO 13766, ISO 14982, ISO 7637-2	CISPR 25 Class 3, ISO 13766, ISO 14982, ISO 7637-2
<b>Electronics:</b>	Integrated	Integrated
<b>Shock:</b>	60G	60G
<b>Vibration:</b>	15.3Grms 24-2000Hz	15.3Grms 24-2000Hz
<b>IP Rating:</b>	IP68, IP6K9K, SAE J1455	IP68, IP6K9K, SAE J1455
<b>Weight:</b>	1.2kg	1.2kg
<b>Operating Temperatures:</b>	-40°C... +85°C (Overheat protected)	-40°C... +85°C (Overheat protected)



## LIGHT PATTERNS

**N3301 4200lm High Beam**

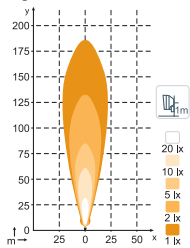

**N3301 4200lm Low Beam**

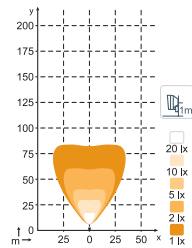

**N3301 4200lm Wide Flood**

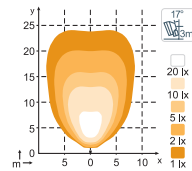

**N3302 3000lm High Beam**

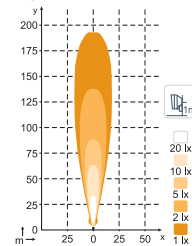

**N3302 3000lm Low Beam**

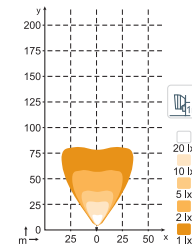

**N3302 3000lm Wide Flood**

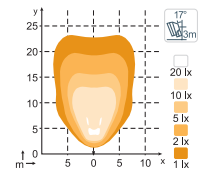

**N3301 4200lm Flood**

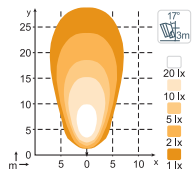

**N3301 3360lm Diffused**

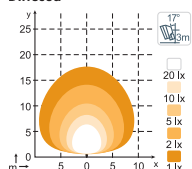

**N3302 3000lm Flood**

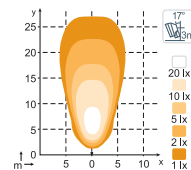

**N3302 2400lm Diffused**

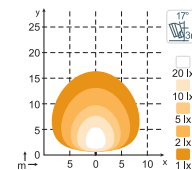



## TECHNICAL SPECIFICATIONS

## ANTARES LED N3303

## ANTARES LED N3304

Theoretical / Operational Lumens Output:	3700lm / 2300lm	3200lm / 2000lm
Colour Temperature:	5700K	5700K
Nominal / Input Voltage DC:	12-24V / 9-32V	12-24V / 9-32V
Power Consumption:	40W	40W
Nominal Current:	24V: 1.7A, 12V: 3.4A	24V: 1.7A, 12V: 3.4A
Mount:	Single Bolt M10	Single Bolt M10
Connector:	Built-in Deutsch DT-2 (2-pin)	Built-in Deutsch DT-2 (2-pin)
EMC:	CISPR 25 Class 3, ISO 13766, ISO 14982, ISO 7637-2	CISPR 25 Class 5, ISO 13766, ISO 14982, ISO 7637-2
Electronics:	Integrated	Integrated
Shock:	60G	60G
Vibration:	15.3Grms 24-2000Hz	15.3Grms 24-2000Hz
IP Rating:	IP68, IP6K9K, SAE J1455	IP68, IP6K9K, SAE J1455
Weight:	1.2kg	1.2kg
Operating Temperatures:	-40°C... +85°C (Overheat protected)	-40°C... +85°C (Overheat protected)

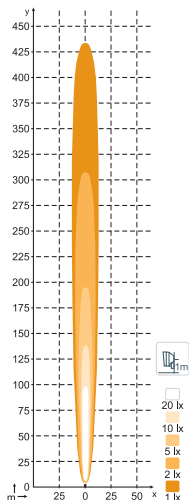
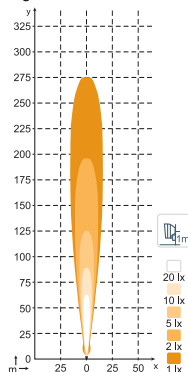
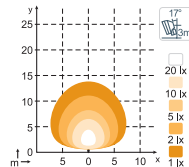
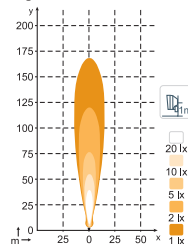
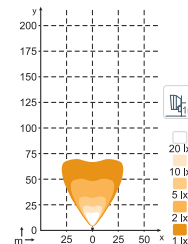
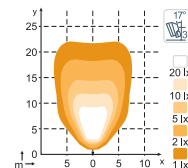
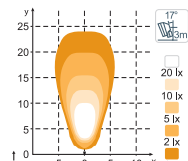
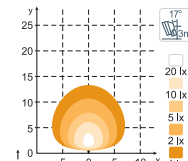

## LIGHT PATTERNS

N3303 2300lm  
Pencil BeamN3303 2300lm  
High BeamN3303 1840lm  
DiffusedN3304 2000lm  
High BeamN3304 2000lm  
Low BeamN3304 2000lm  
Wide FloodN3304 2000lm  
FloodN3304 1600lm  
Diffused

# VIRGO

## MEASUREMENTS

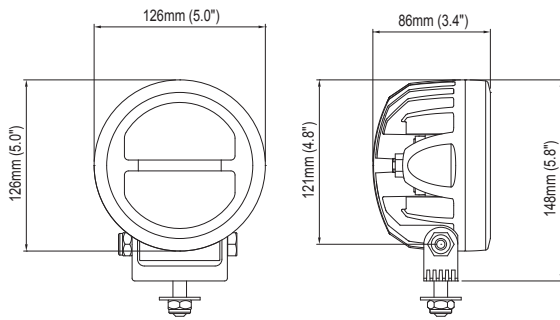

# WHEN LOO

The Virgo is the round sibling of the Scorpius. The Virgo is used in mining, construction, forestry, trucking, emergency response, agriculture, and material handling. It has an asymmetric wide flood feature, making it the best light pattern you will find on the market, particularly suitable for large open spaces. Virgo has pedestal mounting and an output ranging from 2000 to 4200 lumens.



# KS MATTER





## TECHNICAL SPECIFICATIONS

### VIRGO LED N3101

### VIRGO LED N3102

<b>Theoretical / Operational Lumens Output:</b>	6700lm / 4200lm	4800lm / 3000lm
<b>Colour Temperature:</b>	5700K	5700K
<b>Nominal / Input Voltage DC:</b>	12-24 V / 9-32V	12-24V / 9-32V
<b>Power Consumption:</b>	50W	45W
<b>Nominal Current:</b>	24V: 2.1A, 12V: 4.2A	24V: 1.9A, 12V: 3.8A
<b>Mount:</b>	Single Bolt M10	Single Bolt M10
<b>Connector:</b>	Built-in Deutsch DT-2 (2-pin)	Built-in Deutsch DT-2 (2-pin)
<b>EMC:</b>	CISPR 25 Class 3, ISO 13766, ISO 14982, ISO 7637-2	CISPR 25 Class 5, ISO 13766, ISO 14982, ISO 7637-2
<b>Electronics:</b>	Integrated	Integrated
<b>Shock:</b>	60G	60G
<b>Vibration:</b>	15.3Grms 24-2000Hz	15.3Grms 24-2000Hz
<b>IP Rating:</b>	IP68, IP6K9K, SAE J1455	IP68, IP6K9K, SAE J1455
<b>Weight:</b>	1.3kg	1.3kg
<b>Operating Temperatures:</b>	-40°C... +85°C (Overheat protected)	-40°C... +85°C (Overheat protected)



## LIGHT PATTERNS

**N3101 4200lm  
High Beam**

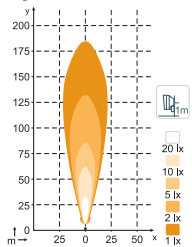

**N3101 4200lm  
Low Beam**

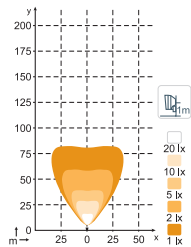

**N3101 4200lm  
Wide Flood**

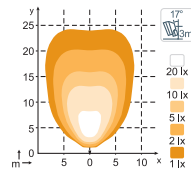

**N3101 4200lm  
Flood**

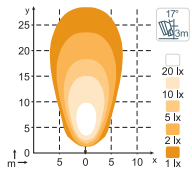

**N3101 3360lm  
Diffused**

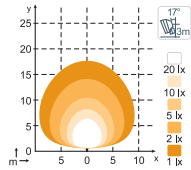

**N3102 3000lm  
High Beam**

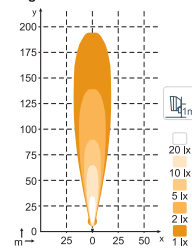

**N3102 3000lm  
Low Beam**

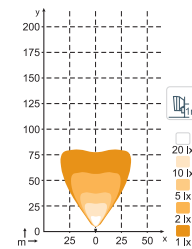

**N3102 3000lm  
Wide Flood**

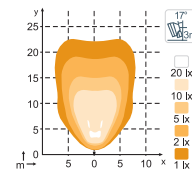

**N3102 3000lm  
Flood**

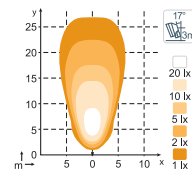

**N3102 2400lm  
Diffused**

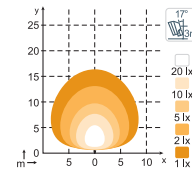



## TECHNICAL SPECIFICATIONS

## VIRGO LED N3103

## VIRGO LED N3104

Theoretical / Operational Lumens Output:	3700lm / 2300lm	3200lm / 2000lm
Colour Temperature:	5700K	5700K
Nominal / Input Voltage DC:	12-24V / 9-32V	12-24V / 9-32V
Power Consumption:	40W	40W
Nominal Current:	24V: 1.7A, 12V: 3.4A	24V: 1.7A, 12V: 3.4A
Mount:	Single Bolt M10	Single Bolt M10
Connector:	Built-in Deutsch DT-2 (2-pin)	Built-in Deutsch DT-2 (2-pin)
EMC:	CISPR 25 Class 3, ISO 13766, ISO 14982, ISO 7637-2	CISPR 25 Class 5, ISO 13766, ISO 14982, ISO 7637-2
Electronics:	Integrated	Integrated
Shock:	60G	60G
Vibration:	15.3Grms 24-2000Hz	15.3Grms 24-2000Hz
IP Rating:	IP68, IP6K9K, SAE J1455	IP68, IP6K9K, SAE J1455
Weight:	1.3kg	1.3kg
Operating Temperatures:	-40°C... +85°C (Overheat protected)	-40°C... +85°C (Overheat protected)

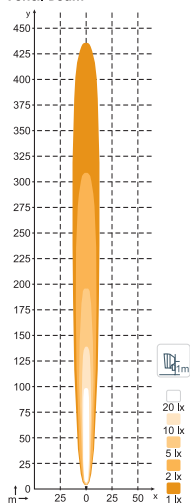
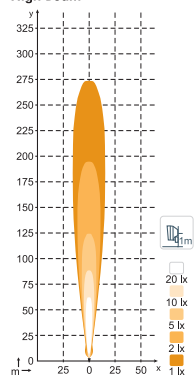
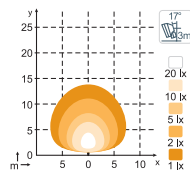
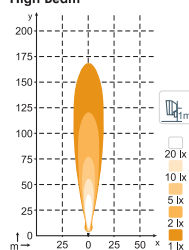
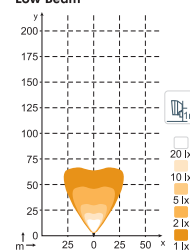
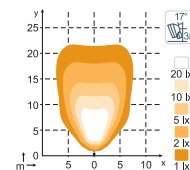
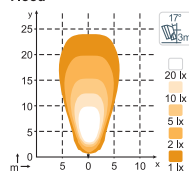
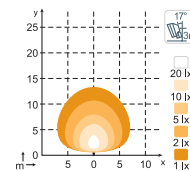

## LIGHT PATTERNS

N3103 2300lm  
Pencil BeamN3103 2300lm  
High BeamN3103 1840lm  
DiffusedN3104 2000lm  
High BeamN3104 2000lm  
Low BeamN3104 2000lm  
Wide FloodN3104 2000lm  
FloodN3104 1600lm  
Diffused



## TECHNICAL SPECIFICATIONS

## VIRGO LED N31

Theoretical / Operational Lumens Output:	3400lm / 2100lm
Colour Temperature:	5700K
Nominal / Input Voltage DC:	12-24V / 9-32V
Power Consumption:	35W
Nominal Current:	24V: 1.5A, 12V: 3.0A
Mount:	Single Bolt M10
Connector:	Built-in Deutsch DT-2 (2-pin)
EMC:	CISPR 25 Class 3, ISO 13766, ISO 14982, ISO 7637-2
Electronics:	Integrated
Shock:	60G
Vibration:	15.3Grms 24-2000Hz
IP Rating:	IP68, IP6K9K, SAE J1455
Weight:	1.6kg
Operating Temperatures:	-40°C... +85°C (Overheat protected)

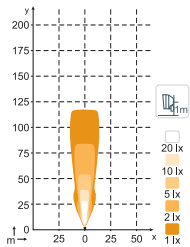
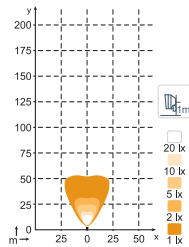
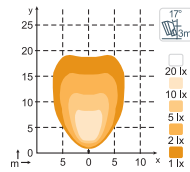
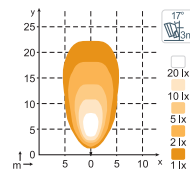
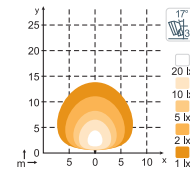

## LIGHT PATTERNS

N31 2100lm  
High BeamN31 2100lm  
Low BeamN31 2100lm  
Wide FloodN31 2100lm  
FloodN31 1680lm  
Diffused





## SPICA

## MEASUREMENTS

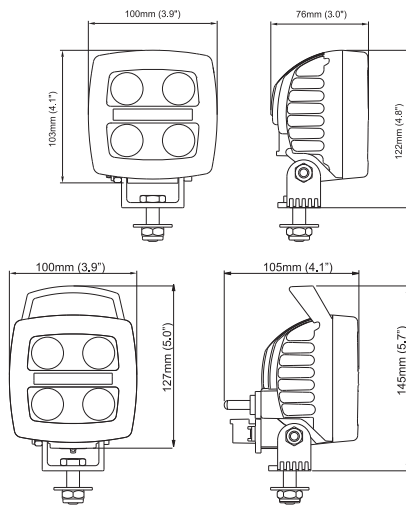

## SMALL YET

The Spica series is crafted for smaller heavy-duty machinery like forklifts, tow tractors, telehandlers, ambulances, tractor-trailers, cement mixers, fire engines, flatbed trucks, garbage trucks, panel vans, pickups, utility vans, and water tenders. The light is dimmable and suitable for work in urban areas. The Spica series has a square form factor and an output between 450 and 750 lumens.

# POWERFUL





## TECHNICAL SPECIFICATIONS

### SPICA LED N2401

### SPICA LED N26

<b>Theoretical / Operational Lumens Output:</b>	1200lm / 750lm	1100lm / 700lm
<b>Colour Temperature:</b>	5700K	5700K
<b>Nominal / Input Voltage DC:</b>	12-24V / 9-32V	12-80V / 9-110V
<b>Power Consumption:</b>	24W	17W
<b>Nominal Current:</b>	24V: 1.0A, 12V: 2.0A	80V: 0.21A, 48V: 0.35A, 24V: 0.7A, 12V: 1.4A
<b>Mount:</b>	Single Bolt M10, Single Bolt M8	Single Bolt M10, Single Bolt M8
<b>Connector:</b>	Built-in AMP, Built-in Deutsch DT-2 (2-pin)	Built-in AMP, Built-in Deutsch DT-2 (2-pin)
<b>EMC:</b>	CISPR 25 Class 5, EN 12895 , ISO 13766, ISO 14982, ISO 7637-2	CISPR 25 Class 3, EN 12895, ISO 13766, ISO 14982, ISO 7637-2
<b>Electronics:</b>	Integrated / Isolated	Integrated / Isolated
<b>Shock:</b>	60G	60G
<b>Vibration:</b>	8Grms 24-2000Hz	8Grms 24-2000Hz
<b>IP Rating:</b>	IP68, IP6K9K, SAE J1455	IP68, IP6K9K, SAE J1455
<b>Weight:</b>	0.9kg	0.9kg
<b>Operating Temperatures:</b>	-40°C... +85°C (Overheat protected)	-40°C... +85°C (Overheat protected)



## LIGHT PATTERNS

**N2401 750lm  
High Beam**

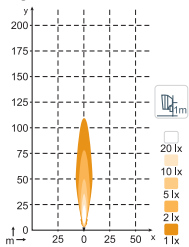

**N2401 750lm  
Wide Flood**

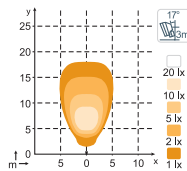

**N2401 600lm  
Diffused**

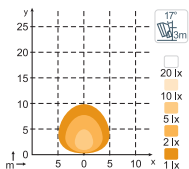

**N2401 750lm  
Flood**

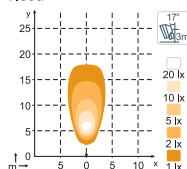

**N26 700lm  
High Beam**

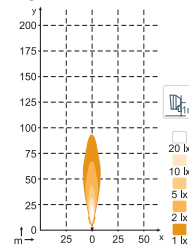

**N26 700lm  
Wide Flood**

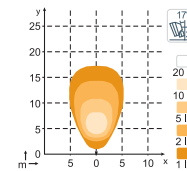

**N26 700lm  
Flood**

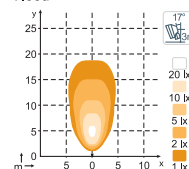

**N26 560lm  
Diffused**

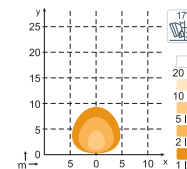



## TECHNICAL SPECIFICATIONS

## SPICA LED N24

## SPICA LED N24 HS

<b>Theoretical / Operational Lumens Output:</b>	1000lm / 600lm	1000lm/ 600lm
<b>Colour Temperature:</b>	6000K	6000K
<b>Nominal / Input Voltage DC:</b>	12-24V / 9-32V	12-24V / 9-32V
<b>Power Consumption:</b>	18W	18W
<b>Nominal Current:</b>	24V: 0.75A, 12V: 1.5A	24V: 0.75A, 12V: 1.5A
<b>Mount:</b>	Single Bolt M10, Single Bolt M8	Single Bolt M10, Single Bolt M8
<b>Connector:</b>	Built-in AMP, Built-in Deutsch DT-2 (2-pin)	Built-in AMP, Built-in Deutsch DT-2 (2-pin)
<b>EMC:</b>	CISPR 25 Class 3, EN 12895 , ISO 13766, ISO 14982, ISO 7637-2	CISPR 25 Class 3, EN 12895, ISO 13766, ISO 14982, ISO 7637-2
<b>Electronics:</b>	Integrated / Isolated	Integrated / Isolated
<b>Shock:</b>	60G	60G
<b>Vibration:</b>	8Grms 24-2000Hz	8Grms 24-2000Hz
<b>IP Rating:</b>	IP68, IP6K9K, SAE J1455	IP68, IP6K9K, SAE J1455
<b>Weight:</b>	0.9kg	0.9kg
<b>Operating Temperatures:</b>	-40°C... +85°C (Overheat protected)	-40°C... +85°C (Overheat protected)

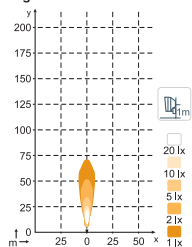
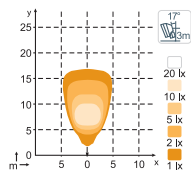
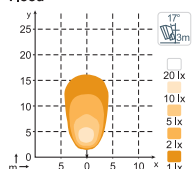
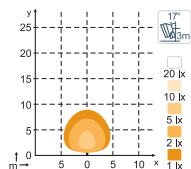
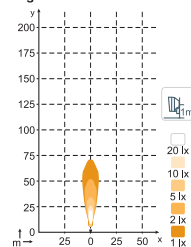
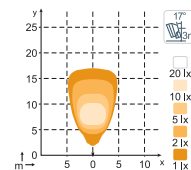
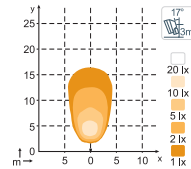
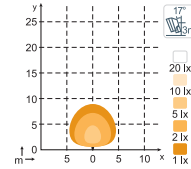

## LIGHT PATTERNS

N24 600lm  
High BeamN24 600lm  
Wide FloodN24 600lm  
FloodN24 480lm  
DiffusedN24 HS 600lm  
High BeamN24 HS 600lm  
Wide FloodN24 HS 600lm  
FloodN24 HS 480lm  
Diffused



## TECHNICAL SPECIFICATIONS

## SPICA LED N24 R (ECE R23)

<b>Theoretical / Operational Lumens Output:</b>	700lm / 450lm
<b>Colour Temperature:</b>	5000K
<b>Nominal / Input Voltage DC:</b>	12-24V / 9-32V
<b>Power Consumption:</b>	15W
<b>Nominal Current:</b>	24V: 0.6A, 12V: 1.2A
<b>Mount:</b>	Single Bolt M10, Single Bolt M8
<b>Connector:</b>	Built-in AMP, Built-in Deutsch DT-2 (2-pin)
<b>EMC:</b>	CISPR 25 Class 3, EN 12895, ISO 13766, ISO 14982, ISO 7637-2, R10
<b>Electronics:</b>	Isolated
<b>Shock:</b>	60G
<b>Vibration:</b>	8Grms 24-2000Hz
<b>IP Rating:</b>	IP68, IP6K9K, SAE J1455
<b>Weight:</b>	0.9kg
<b>Operating Temperatures:</b>	-40°C... +85°C (Overheat protected)

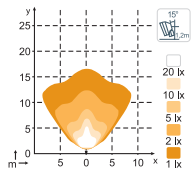

## LIGHT PATTERNS

N24 R 450lm  
Reverse



## CANIS

## MEASUREMENTS

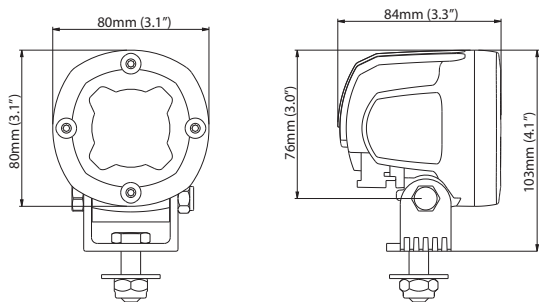

## THE POWER

This is one of our smallest lights, with a single lamp, and a super wide light pattern. Produced with skid-steer loaders and telehandlers in mind, this light is suitable for mounting in tight spaces and delivers strong illumination relative to its size. The Canis product family has a round form factor, pedestal mounting, and a light output of 1000 lumens.



# POWERFUL SINGLE-LED





TECHNICAL SPECIFICATIONS	CANIS LED N2001	CANIS LED N2002 R (ECE R23)
Theoretical / Operational Lumens Output:	1600lm / 1000lm	770lm / 480lm
Colour Temperature:	5700K	5700K
Nominal / Input Voltage DC:	12-48V / 9-68V	12-48V / 9-68V
Power Consumption:	13W	13W
Nominal Current:	48V: 0.25A, 24V: 0.5A, 12V: 1.0A	48V: 0.25A, 24V: 0.5A, 12V: 1.0A
Mount:	Single Bolt M10, Single Bolt M8	Single Bolt M10, Single Bolt M8
Connector:	Built-in Deutsch DT-2 (2-pin)	Built-in Deutsch DT-2 (2-pin)
EMC:	CISPR 25 Class 3, EN 12895 , ISO 13766, ISO 14982, ISO 7637-2	CISPR 25 Class 3, EN 12895, ISO 13766, ISO 14982, ISO 7637-2, R10
Electronics:	Integrated	Integrated
Shock:	60G	60G
Vibration:	15.3Grms 24-2000Hz	8Grms 24-2000Hz
IP Rating:	IP68, IP6K9K, SAE J1455	IP68, IP6K9K, SAE J1455
Weight:	0.6kg	0.6kg
Operating Temperatures:	-40°C... +85°C (Overheat protected)	-40°C... +85°C (Overheat protected)

## ▽ LIGHT PATTERNS

**N2001 1000lm High Beam**

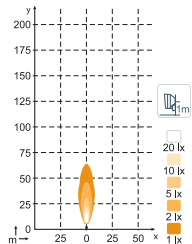

**N2001 1000lm Super Wide**

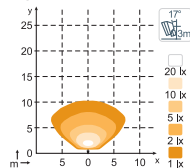

**N2001 1000lm Wide Flood**

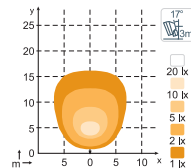

**N2002 480lm Reverse**

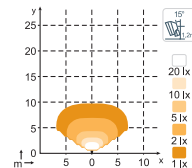

**N2001 800lm Diffused**

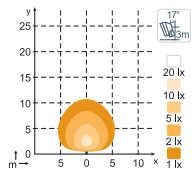

**N2001 1000lm Flood**

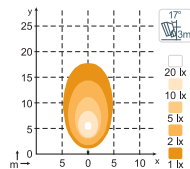



# CAPELLA

## MEASUREMENTS

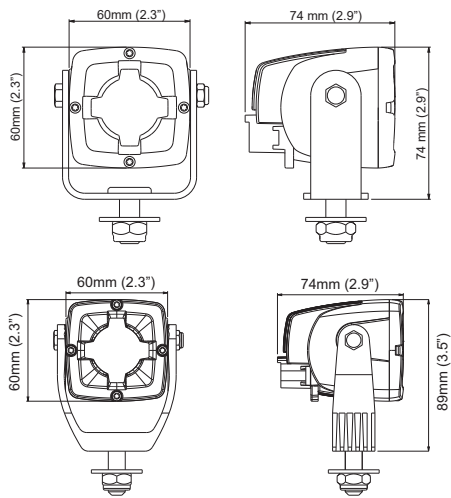

# THE HIDDEN

The Capella work light is extremely compact in size. It is one of the smallest work lights in our product range, designed to fit in very tight places. The Capella comes in two versions, one of which features a stronger bracket for an increased vibration resistance of up to 15.3 Grms. In the Capella product family there are four light patterns available: flood, wide flood, super wide flood, and diffused; with a light output of 350 lumens.



# N GEM





TECHNICAL SPECIFICATIONS

CAPELLA LED N10 B

CAPELLA LED N10

<b>Theoretical / Operational Lumens Output:</b>	550lm / 350lm	550lm / 350lm
<b>Colour Temperature:</b>	6000K	6000K
<b>Nominal / Input Voltage DC:</b>	12-48V / 9-68V	12-48V / 9-68V
<b>Power Consumption:</b>	6W	6W
<b>Nominal Current:</b>	48V: 0.13A, 24V: 0.25A, 12V: 0.5A	48V: 0.13A, 24V: 0.25A, 12V: 0.5A
<b>Mount:</b>	Single Bolt M10	Single Bolt M10
<b>Connector:</b>	Built-in Deutsch DT-2 (2-pin)	Built-in Deutsch DT-2 (2-pin)
<b>EMC:</b>	CISPR 25 Class 3, EN 12895 , ISO 13766, ISO 14982, ISO 7637-2	CISPR 25 Class 3, EN 12895, ISO 13766, ISO 14982, ISO 7637-2
<b>Electronics:</b>	Integrated	Integrated
<b>Shock:</b>	60G	60G
<b>Vibration:</b>	15.3Grms 24-2000Hz	8Grms 24-2000Hz
<b>IP Rating:</b>	IP68, IP6K9K, SAE J1455	IP68, IP6K9K, SAE J1455
<b>Weight:</b>	0.3kg	0.3kg
<b>Operating Temperatures:</b>	-40°C... +85°C (Overheat protected)	-40°C... +85°C (Overheat protected)



LIGHT PATTERNS

N10 B and N10 350lm Super Wide

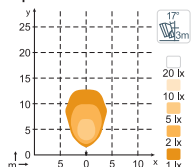

N10 B and N10 350lm Wide Flood

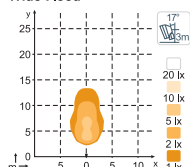

N10 B and N10 350lm Flood

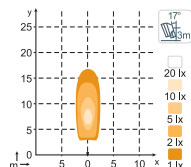

N10 B and N10 300lm Diffused

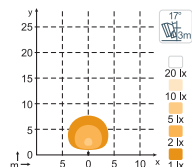



## GO SERIES



## THE STEP-

**SCORPIUS GO**

Our entry-level Scorpius Go is easy to use. Lighter than the original, it has only two light pattern options: flood and wide flood. Useful in construction, forestry, agriculture, and material handling, the Scorpius product family has a square form factor and pedestal mounting. The light produces zero emissions (EMC CISPR 25 class 5) and its light output is up to 1800 lumens.

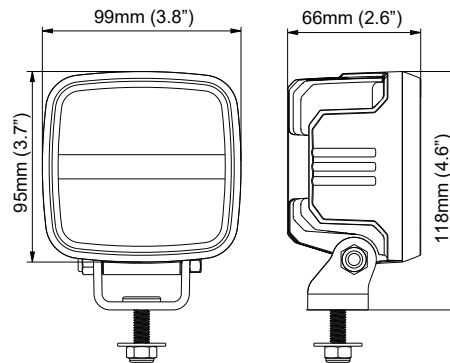



# IT-UP SERIES

## CANIS GO

Our entry-level Canis Go is as good as it gets. While it is lighter than the original, the operational lumen output is just as high. Best suited to construction, forestry, agriculture, and material handling, the Canis Go has a round form factor and pedestal mounting, it produces zero emissions (EMC CISPR 25 class 5) and its light output is up to 1800 lumens.

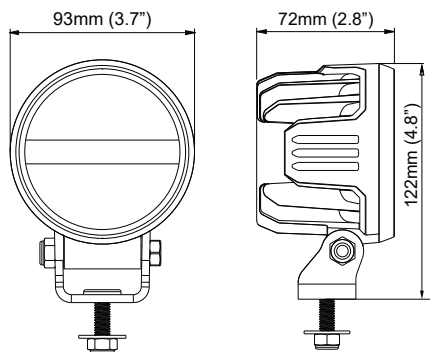

## ANTARES GO

Our entry-level Antares Go is an easy light to use if you are new to NORDIC LIGHTS® products. It has one maximum operational lumens output and two light patterns: flood and wide flood. Best suited to construction, forestry, and agriculture, the Antares Go has an oval form factor and pedestal mounting, it produces zero emissions (EMC CISPR 25 class 5) and its light output is up to 2300 lumens.

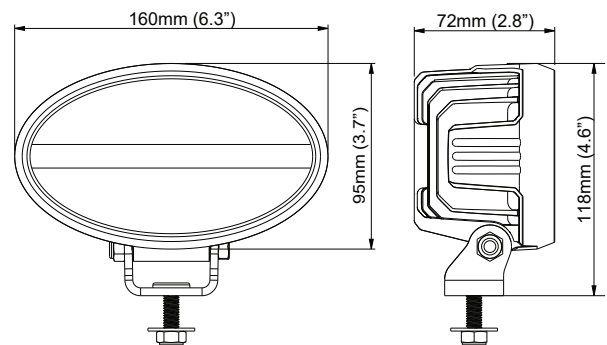



TECHNICAL SPECIFICATIONS	SCORPIUS GO 410	SCORPIUS GO 420
Theoretical / Operational Lumens Output:	1600lm / 1000lm	2800lm / 1800lm
Colour Temperature:	5000K	5000K
Nominal / Input Voltage DC:	12V, 24V / 9-16V, 18-32V	12V, 24V / 9-16V, 18-32V
Power Consumption:	16W	28W
Nominal Current:	@24V=0.60A, @12V=1.05A, @48V=0.38A	@24V=1.00A, @12V=1.80A
Mount:	Single Bolt M8	Single Bolt M8
Connector:	Built-in Deutsch DT-2 (2-pin)	Built-in Deutsch DT-2 (2-pin)
EMC:	CISPR 25 Class 5, EN12895, ISO 13766, ISO 14982, ISO 7637-2	CISPR 25 Class 5, EN12895, ISO 13766, ISO 14982, ISO 7637-2
Electronics:	Integrated	Integrated
Shock:	60G	60G
Vibration:	8Grms 24-2000 Hz	8Grms 24-2000 Hz
IP Rating:	IP68, IP6K9K	IP68, IP6K9K
Weight:	0.6kg	0.6kg
Operating Temperatures:	-40°C... +85°C (Overheat protected)	-40°C... +85°C (Overheat protected)

▽ LIGHT PATTERNS

Scorpius Go 410 1000lm Wide Flood

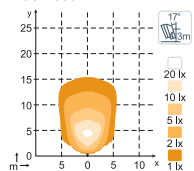

Scorpius Go 410 1000lm Flood

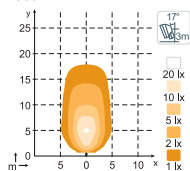

Scorpius Go 420 1800lm Wide Flood

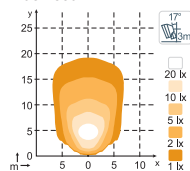

Scorpius Go 420 1800lm Flood

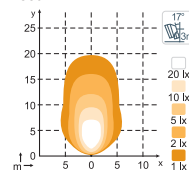



## TECHNICAL SPECIFICATIONS

## CANIS GO 410

## CANIS GO 420

Theoretical / Operational Lumens Output:	1600lm / 1000lm	2800lm / 1800lm
Colour Temperature:	5000K	5000K
Nominal / Input Voltage DC:	12V, 24V / 9-16V, 18-32V	12V, 24V / 9-16V, 18-32V
Power Consumption:	16W	28W
Nominal Current:	@24V=0.60A, @12V=1.05A	@24V=1.00A, @12V=1.80A
Mount:	Single Bolt M8	Single Bolt M8
Connector:	Built-in Deutsch DT-2 (2-pin)	Built-in Deutsch DT-2 (2-pin)
EMC:	CISPR 25 Class 5, EN12895, ISO 13766, ISO 14982, ISO 7637-2	CISPR 25 Class 5, EN12895, ISO 13766, ISO 14982, ISO 7637-2
Electronics:	Integrated	Integrated
Shock:	60G	60G
Vibration:	8Grms 24-2000 Hz	8Grms 24-2000 Hz
IP Rating:	IP68, IP6K9K	IP68, IP6K9K
Weight:	0.5kg	0.5kg
Operating Temperatures:	-40°C... +85°C (Overheat protected)	-40°C... +85°C (Overheat protected)

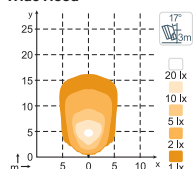
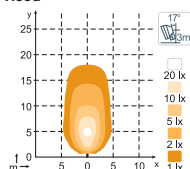
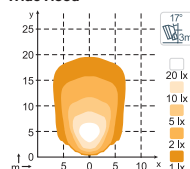
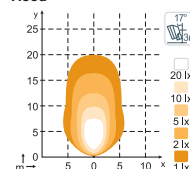

## LIGHT PATTERNS

Canis Go 410 1000lm  
Wide FloodCanis Go 410 1000lm  
FloodCanis Go 420 1800lm  
Wide FloodCanis Go 420 1800lm  
Flood



TECHNICAL SPECIFICATIONS

ANTARES GO 610

ANTARES GO 625

<b>Theoretical / Operational Lumens Output:</b>	1600lm / 1000lm	3600lm / 2300lm
<b>Colour Temperature:</b>	5000K	5000K
<b>Nominal / Input Voltage DC:</b>	12V, 24V / 9-16V, 18-32V	12V, 24V / 9-16V, 18-32V
<b>Power Consumption:</b>	16W	39W
<b>Nominal Current:</b>	@24V=0.60A, @12V=1.05A	@24V=1.40A, @12V=2.50A
<b>Mount:</b>	Single Bolt M8	Single Bolt M8
<b>Connector:</b>	Built-in Deutsch DT-2 (2-pin)	Built-in Deutsch DT-2 (2-pin)
<b>EMC:</b>	CISPR 25 Class 5, EN12895, ISO 13766, ISO 14982, ISO 7637-2	CISPR 25 Class 5, EN12895, ISO 13766, ISO 14982, ISO 7637-2
<b>Electronics:</b>	Integrated	Integrated
<b>Shock:</b>	60G	60G
<b>Vibration:</b>	8Grms 24-2000 Hz	8Grms 24-2000 Hz
<b>IP Rating:</b>	IP68, IP6K9K	IP68, IP6K9K
<b>Weight:</b>	0.8kg	0.8kg
<b>Operating Temperatures:</b>	-40°C... +85°C (Overheat protected)	-40°C... +85°C (Overheat protected)



LIGHT PATTERNS

Antares Go 610 1000lm  
Wide Flood

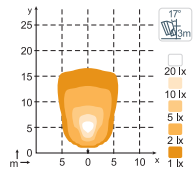

Antares Go 610 1000lm  
Flood

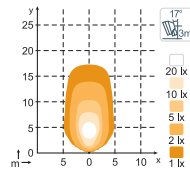

Antares Go 625 2300lm  
Wide Flood

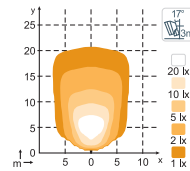

Antares Go 625 2300lm  
Flood

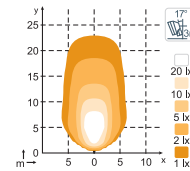



## KL SERIES



# THE AFFOR

We designed the KL series with both new and existing customers in mind. The KL work lights are an excellent choice when you're in need of an upgrade, whether replacing halogen work lights with LEDs or looking for a cost-effective alternative for your heavy-duty equipment. This series offers lights with bracket mounting and with surface mounting on application bodies. Our introductory level KL lights are low-maintenance and withstand vibration up to 8 Grms. Light output in the series varies from 300 to 2000 lumens.

# DABLE ONE





TECHNICAL SPECIFICATIONS	KL1001 LED	KL1002 LED
Theoretical / Operational Lumens Output:	1600lm / 1000lm	2400lm / 1500 lm
Colour Temperature:	5700K	5700K
Nominal / Input Voltage DC:	12-24V / 9-32V	12-24V / 9-32V
Power Consumption:	24W	24W
Nominal Current:	24V: 1.0A, 12V: 2.0A	24V: 1.0A, 12V: 2.0A
Mount:	Single Bolt M10, Single Bolt M8	Single Bolt M10, Single Bolt M8
Connector:	Fly Leads, Pigtail Deutsch 2-pin	Fly Leads, Pigtail Deutsch 2-pin
EMC:	CISPR 25 Class 5, EN 12895 , ISO 13766, ISO 14982, ISO 7637-2	CISPR 25 Class 5, EN 12895, ISO 13766, ISO 14982, ISO 7637-2
Electronics:	Integrated / Isolated	Integrated / Isolated
Shock:	60G	60G
Vibration:	8Grms 24-2000Hz (with HD bracket)	8Grms 24-2000Hz (with HD bracket)
IP Rating:	IP68, IP6K9K, SAE J1455	IP68, IP6K9K, SAE J1455
Weight:	0.7kg	0.7kg
Operating Temperatures:	-40°C... +85°C (Overheat protected)	-40°C... +85°C (Overheat protected)

▽ LIGHT PATTERNS

KL1001 1000lm Flood

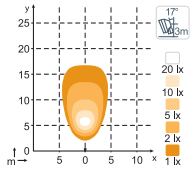

KL1001 800lm Diffused

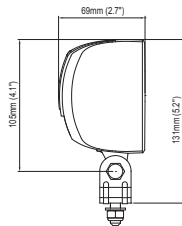
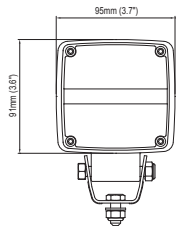
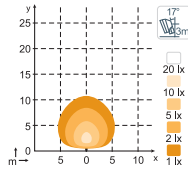

KL1002 1500lm Flood

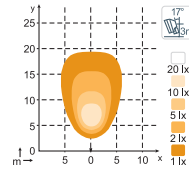

KL1002 1200lm Diffused

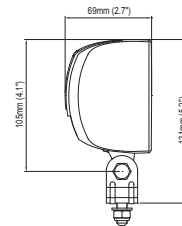
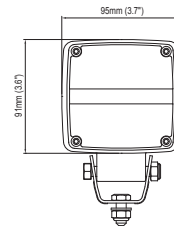
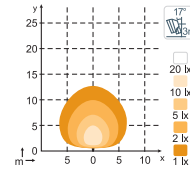





TECHNICAL SPECIFICATIONS	KL1101 LED	KL1102 LED
<b>Theoretical / Operational Lumens Output:</b>	1600lm / 1000lm	2400lm / 1500lm
<b>Colour Temperature:</b>	5700K	5700K
<b>Nominal / Input Voltage DC:</b>	12-24V / 9-32V	12-24V / 9-32V
<b>Power Consumption:</b>	24W	24W
<b>Nominal Current:</b>	24V: 1.0A, 12V: 2.0A	24V: 1.0A, 12V: 2.0A
<b>Mount:</b>	Integrated	Integrated
<b>Connector:</b>	Fly Leads Pigtail AMP Pigtail Deutsch 2-pin Pigtail PGJ19-5	Fly Leads Pigtail AMP Pigtail Deutsch 2-pin Pigtail PGJ19-5
<b>EMC:</b>	CISPR 25 Class 5, EN 12895, ISO 13766, ISO 14982, ISO 7637-2	CISPR 25 Class 5, EN 12895, ISO 13766, ISO 14982, ISO 7637-2
<b>Electronics:</b>	Integrated / Isolated	Integrated / Isolated
<b>Shock:</b>	60G	60G
<b>Vibration:</b>	8Grms 24-2000Hz	8Grms 24-2000Hz
<b>IP Rating:</b>	IP68, IP6K9K, SAE J1455	IP68, IP6K9K, SAE J1455
<b>Weight:</b>	0.45kg	0.45kg
<b>Operating Temperatures:</b>	-40°C... +85°C (Overheat protected)	-40°C... +85°C (Overheat protected)

▽ LIGHT PATTERNS

KL1101 1000lm Flood

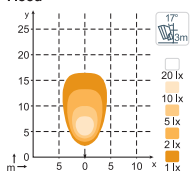

KL1101 800lm Diffused

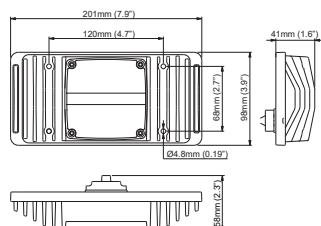
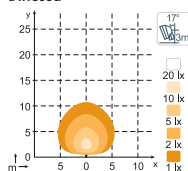

KL1102 1500lm Flood

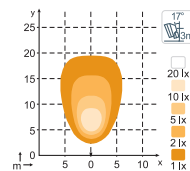

KL1102 1200lm Diffused

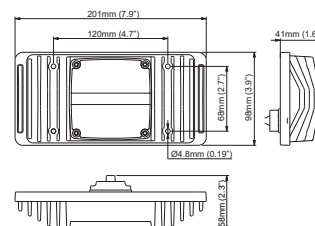
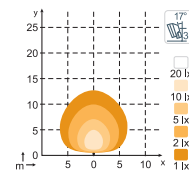



TECHNICAL SPECIFICATIONS

KL1401 LED

KL1501 LED

<b>Theoretical / Operational Lumens Output:</b>	3200lm / 2000lm	500lm / 300lm
<b>Colour Temperature:</b>	5700K	5700K
<b>Nominal / Input Voltage DC:</b>	12-24V / 9-32V	12-24V / 9-32V
<b>Power Consumption:</b>	42W	10W
<b>Nominal Current:</b>	24V: 1.7A, 12V: 3.5A	24V: 0.4A, 12V: 0.8A
<b>Mount:</b>	Single Bolt M10	Single Bolt M8
<b>Connector:</b>	Built-in Deutsch DT-2 (2-pin)	Built-in Deutsch DT-2 (2-pin)
<b>EMC:</b>	CISPR 25 Class 5, EN12895, ISO 13766, ISO 14982, ISO 7637-2	CISPR 25 Class 5, EN12895, ISO 13766, ISO 14982, ISO 7637-2
<b>Electronics:</b>	Integrated	Integrated
<b>Shock:</b>	60G	60G
<b>Vibration:</b>	8Grms 24-2000Hz	8Grms 24-2000Hz
<b>IP Rating:</b>	IP68, IP6K9K, SAE J1455	IP68, IP6K9K, SAE J1455
<b>Weight:</b>	0.9kg	0.2 kg
<b>Operating Temperatures:</b>	-40°C... +85°C (Overheat protected)	-40°C... +85°C (Overheat protected)

▽ LIGHT PATTERNS

KL1401 2000lm  
Wide Flood

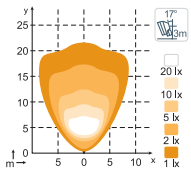

KL1401 2000lm  
Flood

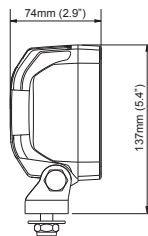
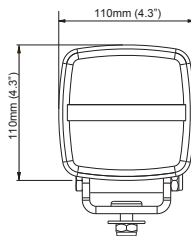
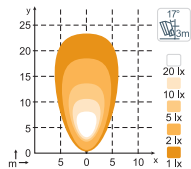

KL1501 300lm  
Flood

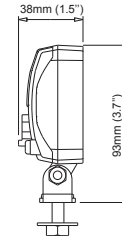
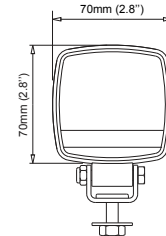
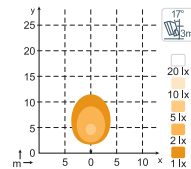



TECHNICAL SPECIFICATIONS

KL2001 LED

Theoretical / Operational Lumens Output:	1900lm / 1200lm
Colour Temperature:	5700K
Nominal / Input Voltage DC:	12-24V / 9-32V
Power Consumption:	20W
Nominal Current:	24V: 0.8A, 12V: 1.7A
Mount:	Single Bolt M8
Connector:	Built-in AMP, Built-in Deutsch DT-2 (2-pin)
EMC:	CISPR 25 Class 5, EN12895, ISO 13766, ISO 14982, ISO 7637-2
Electronics:	Integrated
Shock:	60G
Vibration:	8Grms 24-2000Hz
IP Rating:	IP68, IP6K9K, SAE J1455
Weight:	0.5 kg
Operating Temperatures:	-40°C... +85°C (Overheat protected)



LIGHT PATTERNS

KL2001 1200lm  
Wide Flood

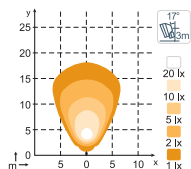

KL2001 1200lm  
Flood

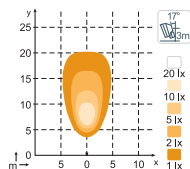

KL2001 900lm  
Diffused

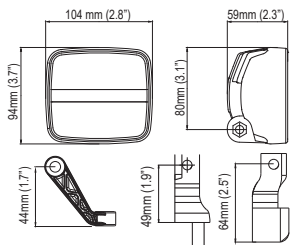
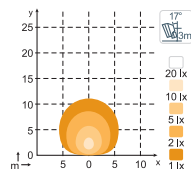

# KL FLUSHMOUNT SERIES



## TECHNICAL SPECIFICATIONS

### KL1301 LED F7°

### KL1302 LED F7°

<b>Theoretical / Operational Lumens Output:</b>	1600lm / 1000lm	2400lm / 1500 lm
<b>Colour Temperature:</b>	5700K	5700K
<b>Nominal / Input Voltage DC:</b>	12-24V / 9-32V	12-24V / 9-32V
<b>Power Consumption:</b>	24W	24W
<b>Nominal Current:</b>	24V: 1.0A, 12V: 2.0A	24V: 1.0A, 12V: 2.0A
<b>Mount:</b>	Integrated	Integrated
<b>Connector:</b>	Fly Leads Pigtail AMP Pigtail Deutsch 2-pin Pigtail PGJ19-5	Fly Leads Pigtail AMP Pigtail Deutsch 2-pin Pigtail PGJ19-5
<b>EMC:</b>	CISPR 25 Class 5, EN 12895 , ISO 13766, ISO 14982, ISO 7637-2	CISPR 25 Class 5, EN 12895, ISO 13766, ISO 14982, ISO 7637-2
<b>Electronics:</b>	Integrated / Isolated	Integrated / Isolated
<b>Shock:</b>	60G	60G
<b>Vibration:</b>	8Grms 24-2000Hz	8Grms 24-2000Hz
<b>IP Rating:</b>	IP68, IP6K9K, SAE J1455	IP68, IP6K9K, SAE J1455
<b>Weight:</b>	0.45kg	0.45kg
<b>Operating Temperatures:</b>	-40°C... +85°C (Overheat protected)	-40°C... +85°C (Overheat protected)



## LIGHT PATTERNS

KL1301, KL1303 1000lm  
Flood

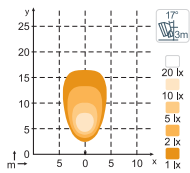

KL1301, KL1303 800lm  
Diffused

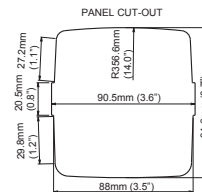
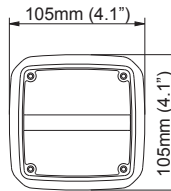
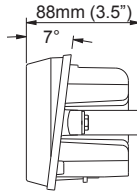
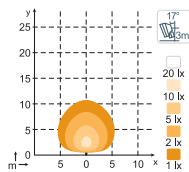



TECHNICAL SPECIFICATIONS

	KL1303 LED F0°	KL1304 LED F0°	KL1305 LED F7° SNAP-IN
<b>Theoretical / Operational Lumens Output:</b>	1600lm / 1000lm	2400lm / 1500 lm	1300lm / 800lm
<b>Colour Temperature:</b>	5700K	5700K	5700K
<b>Nominal / Input Voltage DC:</b>	12-24V / 9-32V	12-24V / 9-32V	12-24V / 9-32V
<b>Power Consumption:</b>	24W	24W	20W
<b>Nominal Current:</b>	24V: 1.0A, 12V: 2.0A	24V: 1.0A, 12V: 2.0A	24V: 0.8A, 12V: 1.7A
<b>Mount:</b>	Integrated	Integrated	Integrated
<b>Connector:</b>	Fly Leads Pigtail AMP Pigtail Deutsch 2-pin Pigtail PGJ19-5	Fly Leads Pigtail AMP Pigtail Deutsch 2-pin Pigtail PGJ19-5	Built-in Deutsch 2-pin
<b>EMC:</b>	CISPR 25 Class 5, EN 12895 , ISO 13766, ISO 14982, ISO 7637-2	CISPR 25 Class 5, EN 12895, ISO 13766, ISO 14982, ISO 7637-2	CISPR 25 Class 5, EN12895, ISO 13766, ISO 14982, ISO 7637-2
<b>Electronics:</b>	Integrated / Isolated	Integrated / Isolated	Integrated
<b>Shock:</b>	60G	60G	60G
<b>Vibration:</b>	8Grms 24-2000Hz	8Grms 24-2000Hz	15.3Grms 24-2000Hz
<b>IP Rating:</b>	IP68, IP6K9K, SAE J1455	IP68, IP6K9K, SAE J1455	IP6K9K, SAE J1455
<b>Weight:</b>	0.45kg	0.45kg	0.5kg
<b>Operating Temperatures:</b>	-40°C... +85°C (Overheat protected)	-40°C... +85°C (Overheat protected)	-40°C... +85°C (Overheat protected)



LIGHT PATTERNS

KL1302, KL1304 1500lm Flood

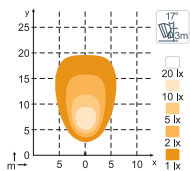

KL1302, KL1304 1200lm Diffused

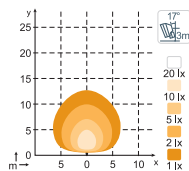

KL1305 800lm Flood

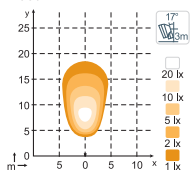

KL1305 700lm Diffused

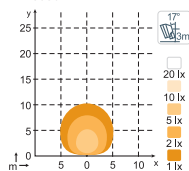

KL1305 800lm Wide Flood

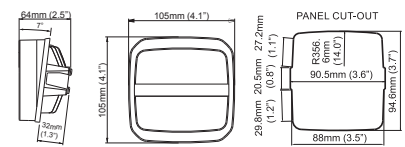
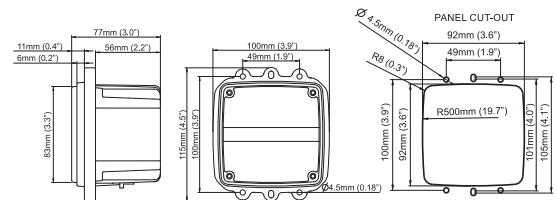
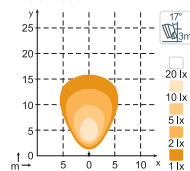

# GEMINI

## MEASUREMENTS

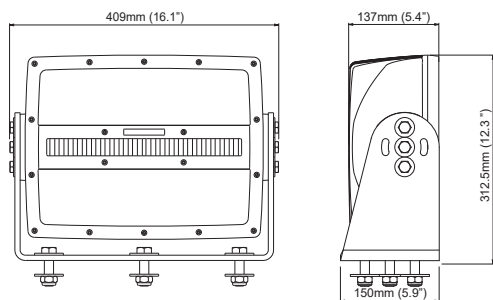

### The King of the Hill

This majestic light has no less than 60 LEDs and weighs 18 kg. The Gemini is mostly used in the mining industry and on bucket-wheel excavators. However, with an output ranging from 13,800 to 25,200 lumens, it also sees use illuminating harbors, generally mounted on harbor masts.

## TECHNICAL SPECIFICATIONS

## GEMINI LED N4701

## GEMINI LED N4702

Theoretical / Operational Lumens Output:	40300lm / 25200lm	28800lm / 18000lm
Colour Temperature:	5700K	5700K
Nominal / Input Voltage DC:	18-32V	18-32V
Power Consumption:	300W	270W
Nominal Current:	12.5A	11.3A
Mount:	5 pcs Bolt M14x35	5 pcs Bolt M14x35
Connector:	2 x Built-in Deutsch DT-2 (2-pin)	2 x Built-in Deutsch DT-2 (2-pin)
EMC:	CISPR 25 Class 3, ISO 13766, ISO 14982, ISO 7637-2	CISPR 25 Class 3, ISO 13766, ISO 14982, ISO 7637-2
Electronics:	Integrated	Integrated
IP Rating:	IP68, IP6K9K	IP68, IP6K9K
Weight:	18kg	18kg
Operating Temperatures:	-40°C... +85°C (Overheat protected)	-40°C... +85°C (Overheat protected)

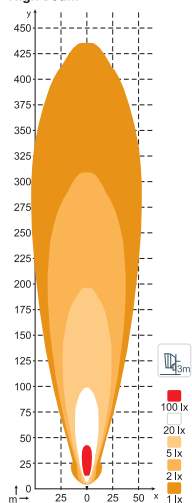
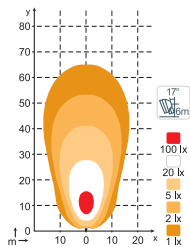
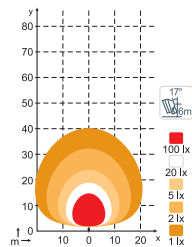
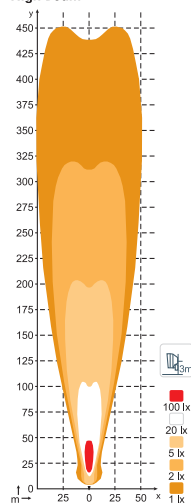
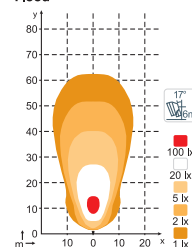
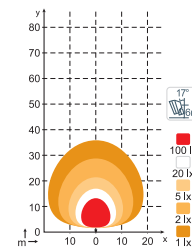

## LIGHT PATTERNS

N4701 25200lm  
High BeamN4701 25200lm  
FloodN4701 20160lm  
DiffusedN4702 18000lm  
High BeamN4702 18000lm  
FloodN4702 14400lm  
Diffused

## TECHNICAL SPECIFICATIONS

## GEMINI LED N4703

Theoretical / Operational Lumens Output:	22000lm / 13800lm
Colour Temperature:	5700K
Nominal / Input Voltage DC:	24V / 18–32V
Power Consumption:	240W
Nominal Current:	24 V / 10A
Mount:	5 pcs Bolt M14x35
Connector:	2 x Built-in Deutsch DT-2 (2-pin)
EMC:	CISPR 25 Class 3
Electronics:	Integrated
IP Rating:	IP68
Weight:	18kg
Operating Temperatures:	-40°C... +85°C (Overheat protected)



## LIGHT PATTERNS

**N4703 13800lm  
Pencil Beam**

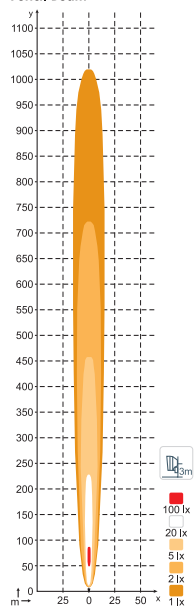

**N4703 13800lm  
High Beam**

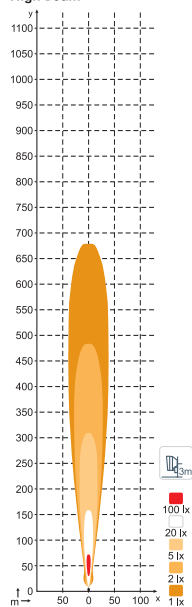

**N4703 11040lm  
Diffused**

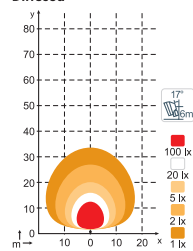





GRONINGEN  
AIRPORT EELDE

4

03-9368

BRANDWEER

5-0000

# PICTOR

## MEASUREMENTS

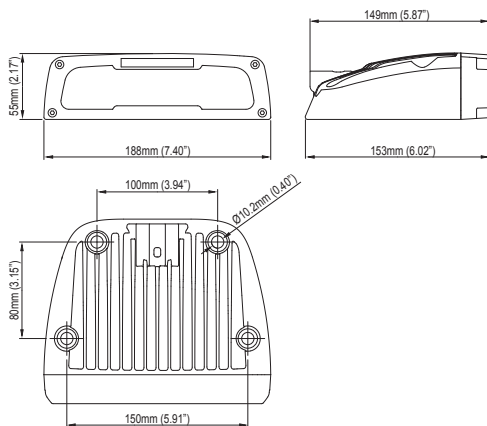

### Extreme Precision Lighting

The Pictor is the most precise of our lights, with an output of 2600 lumens. It is designed to be mounted on equipment booms to optimize lighting in a specific area. The design of the Pictor makes it the most durable boom light on the market. The Pictor is mainly used in the construction industry and is particularly suitable for excavators, telehandlers, and other equipment with a boom.

## TECHNICAL SPECIFICATIONS

## PICTOR LED N7301

Theoretical / Operational Lumens Output:	4100lm / 2600lm
Colour Temperature:	5700K
Nominal / Input Voltage DC:	12-24V / 9-32V
Power Consumption:	32W
Nominal Current:	24V: 1.3A, 12V: 2.7A
Mount:	4 pcs DIN912 M10 (not supplied) 4 pcs DIN912 M8 + DIN125 washer
Connector:	Built-in Deutsch DT-2 (2-pin)
EMC:	CISPR 25 Class 3, ISO 13766, ISO 14982, ISO 7637-2
Electronics:	Integrated
Shock:	60G
Vibration:	15.3Grms 24-2000Hz
IP Rating:	IP68, IP6K9K, SAE J1455
Weight:	1.6kg
Operating Temperatures:	-40°C... +85°C (Overheat protected)



## LIGHT PATTERNS

N7301 2600lm  
Flood TD US

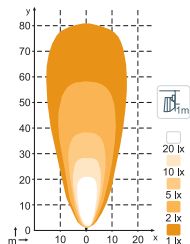

N7301 2600lm  
Flood TT DS

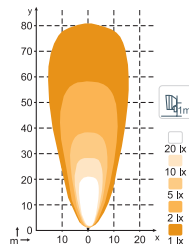

N7301 2600lm  
Flood LH US

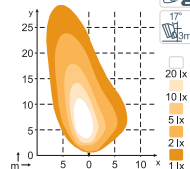

N7301 2600lm  
Flood RH US

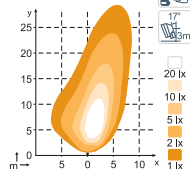

# TAURUS

## MEASUREMENTS

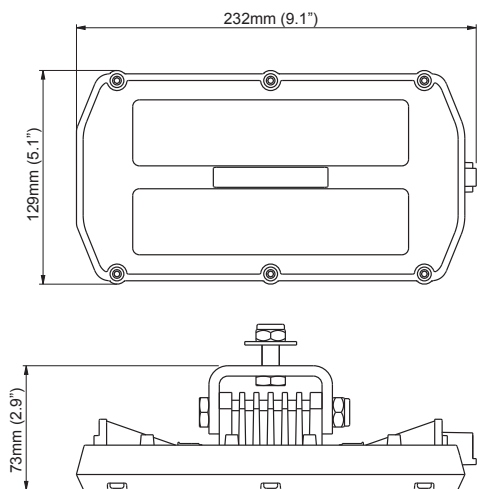

### No Blind Spots

Ideal for illuminating short distances, the Taurus is used primarily in engine rooms. A white plastic cover ensures that those working in its beam will not be blinded. The light pattern is designed to minimize shadows. The Taurus has no less than 54 LEDs and an output of 1950 lumens.

## TECHNICAL SPECIFICATIONS

## TAURUS LED N7201

Theoretical / Operational Lumens Output:	3100lm / 1950lm
Colour Temperature:	5300K
Nominal / Input Voltage DC:	12-24V / 9-32V
Power Consumption:	30W
Nominal Current:	24V: 1.25A, 12V: 2.5A
Mount:	Single Bolt M10
Connector:	Built-in Deutsch DT-2 (2-pin) (left or right)
EMC:	CISPR 25 Class 3, ISO 13766, ISO 14982, ISO 7637-2
Electronics:	Integrated
Shock:	60G
Vibration:	15.3Grms 24-2000Hz
IP Rating:	IP68, IP6K9K, SAE J1455
Weight:	1.3kg
Operating Temperatures:	-40°C... +85°C (Overheat protected)

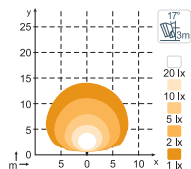

## LIGHT PATTERNS

N7201 1950lm  
Diffused

# DORADO

## MEASUREMENTS

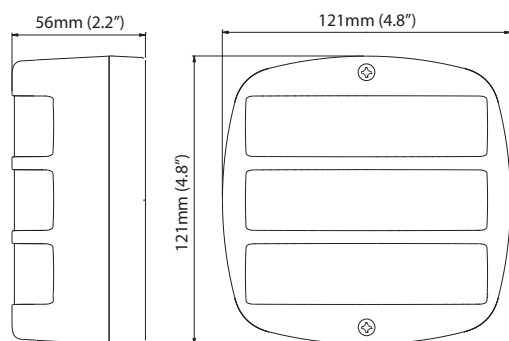

### The Versatile Tail Light

We aim for versatility. This tail light combines tail, stop, and indicator lights all in one unit and can be mounted on most vehicles. Mounting is a snap since this is a tell-tale compatible light, just plug & play. There is no need for an additional flasher relay. The Dorado is durable against both vibration and shock.

TECHNICAL SPECIFICATIONS	DORADO LED N70
<b>Nominal / Input Voltage DC:</b>	24V: 16-32V / 12V: 8-16V
<b>Power Consumption:</b>	Brake 1.4W Indicator 1.4W Tell-tale 24V: Indicator 18W
<b>Nominal Current at 12V:</b>	Brake 116mA Indicator 116mA Tell-tale: Indicator 150mA Tail 34 mA
<b>Nominal Current at 24V:</b>	Brake 58mA Indicator 58mA Tell-tale: Indicator 75mA Tail 17mA
<b>Mount:</b>	M6x25 2pcs
<b>Connector:</b>	4 pin Male Terminal 6.3 x 0.8
<b>EMC:</b>	EN 12895, ISO 13766, ISO 14982, ISO 7637-2
<b>Electronics:</b>	Integrated - Epoxy Encapsulated
<b>Shock:</b>	60G
<b>Vibration:</b>	20Grms 24-2000Hz
<b>Weight:</b>	0.4kg
<b>Operating Temperatures:</b>	-40°C... +85°C (Overheat protected)



# VELA

## MEASUREMENTS

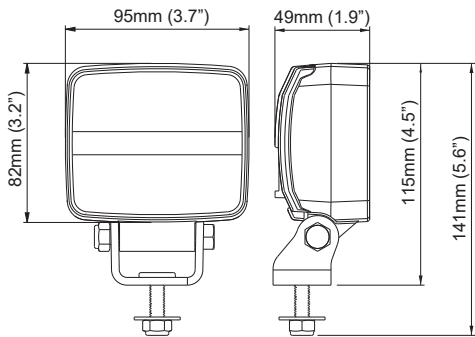

### State of the Art Warning Light

Vela is our innovative safety light that uses isolated, integrated electronics as the cornerstone of its performance. With its light capacity of 470 lumens, it produces a focused blue light that is very useful for illuminating dangerous situations. Whether used on a forklift in a warehouse as an early warning light for approaching vehicles or as a warning light on a tractor, you can be assured that this premium light will fulfil its purpose, making your work environment safer and more efficient.



## TECHNICAL SPECIFICATIONS

## N2201 LED BLUE

Light colour:	Blue (470 lm)
Nominal / Input Voltage DC:	12–48 V
Power Consumption:	16W
Nominal Current at:	48V 0.3A 24V 0.7A 12V 1.4A
Mount:	Single bolt M8
Connector:	Built-in Deutsch 2-pin DT
EMC:	CISPR 25 Class 5 EN12895 ISO 13766 ISO 14982 ISO 7637-2
Shock:	60G
Vibration:	8Grms 24-2000Hz
Weight:	0.5 kg
Operating Temperatures:	-40°C... +85°C (Overheat protected)



## LIGHT PATTERNS

N2201

Spot

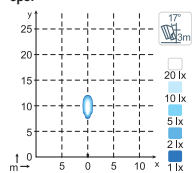

# SCULPTOR

## MEASUREMENTS

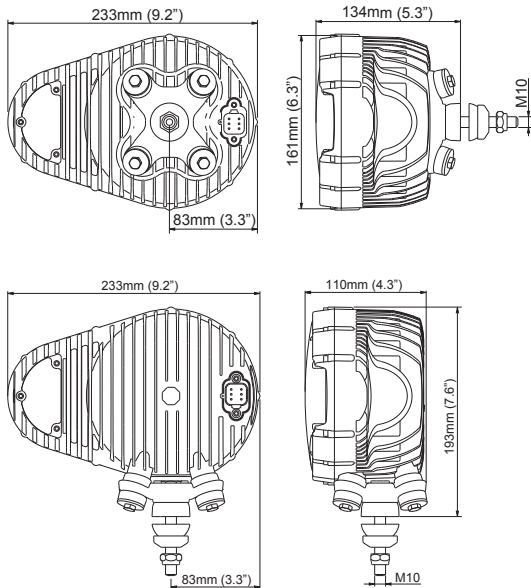

### ECE Approvals:

Passing beam: ECE Regulation 112,

class B for right & left hand traffic

Driving beam: ECE Regulation 112,

class B, Reference number 25

Position light: ECE Regulation 7

Direction Indicator: ECE Regulation 6, class 1b (front)

Direction Indicator: ECE Regulation 6, class 5 (side)



### All-in-One Durable Headlight

The Sculptor driving light integrates headlight, indicator, and parking lights in one unit. Unbeatable in its durability, this light is equipped with our integrated QUAKE dampening system. The combination headlight withstands shocks of 60G and vibration of 15.3 Grms at 24–2000 Hz. This combination light with pedestal mounting is very useful in agricultural, construction, and trucking applications. It has a dual-beam function with both dipped and full beams, which offers any vehicle using this light an amazing advantage.



TECHNICAL SPECIFICATIONS	SCULPTOR LED N6001 QD	SCULPTOR LED N6002 QD
Colour Temperature:	5700K	5700K
Nominal / Input Voltage DC:	12-24V / 9-32V	12-24V / 9-32V
Power Consumption	High Beam 44W Low Beam 22W Park 2.7W Indicator 17.5W	High Beam 44W Low Beam 22W Park 2.7W Indicator 17.5W
Mount:	Single Bolt M10	Single Bolt M10
Connector:	Built-in Deutsch 6-pin	Built-in Deutsch 6-pin
EMC:	CISPR 25 Class 3, EN61000-4-2, ISO 13766, ISO 14982-2, ISO 11145-2, ISO 7637-2	CISPR 25 Class 3, EN61000-4-2, ISO 13766, ISO 14982-2, ISO 11145-2, ISO 7637-2
Electronics:	Integrated	Integrated
Shock:	60G	60G
Vibration:	15.3Grms 24-2000Hz	15.3Grms 24-2000Hz
IP Rating:	IP68, IP6K9K, SAE J1455	IP68, IP6K9K, SAE J1455
Weight:	2.5kg	2.5kg
Operating Temperatures:	-40°C... +85°C (Overheat protected)	-40°C... +85°C (Overheat protected)

▽ LIGHT PATTERNS

N60XX ECE High Beam RHT

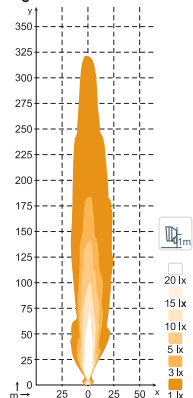

N60XX ECE Low Beam RHT

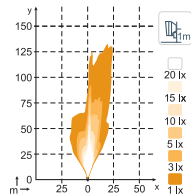

N60XX ECE High Beam LHT

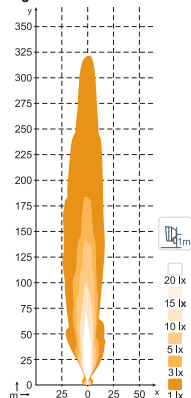

N60XX ECE Low Beam LHT

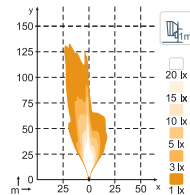



## HEADLIGHTS



PRODUCTS	N523 LED	N520 LED	N503 LED	N500 LED
Approvals:	ECE, SAE	ECE, SAE	ECE, SAE	ECE, SAE
Bulb	H4	H4	H4	H4
Watt & Voltage	60/55W @ 12V   75/70W @ 24V	60/55W @ 12V   75/70W @ 24V	60/55W @ 12V   75/70W @ 24V	60/55W @ 12V   75/70W @ 24V
Light Pattern	High/LowBeam	High/LowBeam	High/LowBeam	High/LowBeam
Mount	M10	M10	M10	M10
Vibration Dampening	D	-	D	-



PRODUCTS	N523 HALOGEN	N520 HALOGEN	N503 HALOGEN	N500 HALOGEN
Approvals:	ECE, SAE	ECE, SAE	ECE, SAE	ECE, SAE
Bulb	H4	H4	H4	H4
Watt & Voltage	60/55W @ 12V   75/70W @ 24V	60/55W @ 12V   75/70W @ 24V	60/55W @ 12V   75/70W @ 24V	60/55W @ 12V   75/70W @ 24V
Light Pattern	High/LowBeam	High/LowBeam	High/LowBeam	High/LowBeam
Mount	M10	M10	M10	M10
Vibration Dampening	D	-	D	-

Connectors: Pigtail Deutsch 6-pin, Built-in AMP 6-pin, Built-in Deutsch 6-pin, Grommet



## HALOGEN WORK LIGHTS



PRODUCTS	N300 HALOGEN SD	N300 HALOGEN SD TP	N300 HALOGEN D	N300 HALOGEN D TP
<b>Bulb</b>	H3/H3 HD	H3/H3 HD	H3/H3 HD	H3/H3 HD
<b>Watt &amp; Voltage</b>	55W@12V   65W@24V HD Bulb   70W@24V	110W@12V   130W@24V HD Bulb   140W@24V	60/55W @ 12V   75/70W @ 24V	60/55W @ 12V   75/70W @ 24V
<b>Light Pattern</b>	Wide Flood	Wide Flood	Wide Flood	Wide Flood
<b>Mount</b>	M8 or M10	M8 or M10	M8 or M10	M8 or M10
<b>Vibration Dampening</b>	SD	SD	D	D



PRODUCTS	N300 HALOGEN D H	N300 HALOGEN D TP H	N300 HALOGEN D R	N300 HALOGEN D H GRILL
<b>Bulb</b>	H3/H3 HD	H3/H3 HD	H3/H3 HD	H3/H3 HD
<b>Watt &amp; Voltage</b>	55W@12V   65W@24V HD Bulb   70W@24V	110W@12V   130W@24V HD Bulb   140W@24V	55W@12V   65W@24V HD Bulb   70W@24V	55W@12V   65W@24V HD Bulb   70W@24V
<b>Light Pattern</b>	Wide Flood	Wide Flood	Wide Flood	Wide Flood
<b>Mount</b>	M8 or M10	M8 or M10	M8 or M10	M8 or M10
<b>Vibration Dampening</b>	D	D	D	D



## HALOGEN WORK LIGHTS



PRODUCTS	N200 HALOGEN XD	N200 HALOGEN D	N200 HALOGEN	N200 HALOGEN D H
<b>Bulb</b>	H3/H3 HD	H3/H3 HD	H3/H3 HD	H3/H3 HD
<b>Watt &amp; Voltage</b>	55W@12V   65W@24V HD Bulb   70W@24V	55W@12V   65W@24V HD Bulb   70W@24V	55W@12V   65W@24V HD Bulb   70W@24V	55W@12V   65W@24V HD Bulb   70W@24V
<b>Light Pattern</b>	Wide Flood, Flood, HighBeam, LowBeam	Wide Flood, Flood, HighBeam, LowBeam	Wide Flood, Flood, HighBeam, LowBeam	Wide Flood, Flood, HighBeam, LowBeam
<b>Mount</b>	M8 or M10	M8 or M10	M8 or M10	M8 or M10
<b>Vibration Dampening</b>	XD	D	-	D



PRODUCTS	N200 HALOGEN H	N100 HALOGEN XD	N100 HALOGEN D	N100 HALOGEN D TP
<b>Bulb</b>	H3/H3 HD	H3/H3 HD	H3/H3 HD	H3/H3 HD
<b>Watt &amp; Voltage</b>	55W@12V   65W@24V HD Bulb   70W@24V	55W@12V   65W@24V HD Bulb   70W@24V	55W@12V   65W@24V HD Bulb   70W@24V	110W@12V   130W@24V HD Bulb   140W@24V
<b>Light Pattern</b>	Wide Flood, Flood, HighBeam, LowBeam	Wide Flood, Flood	Wide Flood, Flood	Wide Flood, Flood
<b>Mount</b>	M8 or M10	M8 or M10	M8 or M10	M8 or M10
<b>Vibration Dampening</b>	-	XD	D	D



## HALOGEN WORK LIGHTS



PRODUCTS	N100 HALOGEN	N100 HALOGEN TP	N100 HALOGEN S	N25 HALOGEN D
<b>Bulb</b>	H3/H3 HD	H3/H3 HD	H3/H3 HD	H3/H3 HD
<b>Watt &amp; Voltage</b>	55W@12V   65W@24V HD Bulb   70W@24V	110W@12V   130W@24V HD Bulb   140W@24V	55W@12V   65W@24V HD Bulb   70W@24V	55W@12V   65W@24V HD Bulb   70W@24V
<b>Light Pattern</b>	Wide Flood, Flood	Wide Flood, Flood	Wide Flood, Flood	Wide Flood, Flood, HighBeam, LowBeam
<b>Mount</b>	M8 or M10	M8 or M10	M8 or M10	M8 or M10
<b>Vibration Dampening</b>	-	-	-	D



PRODUCTS	N25 HALOGEN	N25 HALOGEN D R	N25 HALOGEN R	
<b>Bulb</b>	H3/H3 HD	H3/H3 HD	H3/H3 HD	
<b>Watt &amp; Voltage</b>	55W@12V   65W@24V HD Bulb   70W@24V	110W@12V   130W@24V HD Bulb   140W@24V	55W@12V   65W@24V HD Bulb   70W@24V	
<b>Light Pattern</b>	Wide Flood, Flood, HighBeam, LowBeam	Wide Flood, Flood, HighBeam, LowBeam	Wide Flood, Flood, HighBeam, LowBeam	
<b>Mount</b>	M8 or M10	M8 or M10	M8 or M10	
<b>Vibration Dampening</b>	-	D	-	

**Connectors:** Built-in AMP, Built-in Deutsch DT-2 (2-pin), Fly Leads, Grommet, Pigtail Deutsch 2-pin



PRODUCTS	N25 HALOGEN D I	N25 HALOGEN I
<b>Bulb</b>	12V P21W (BA15s) 24V P21W (BA15s)t	12V P21W (BA15s) 24V P21W (BA15s)
<b>Light Pattern</b>	–	–
<b>Mount</b>	M8 or M10	M8 or M10
<b>Vibration Dampening</b>	D	–

Connectors: Built-in AMP, Built-in Deutsch DT-2 (2-pin), Pigtail Deutsch 2-pin





## HALOGEN FLUSHMOUNT



PRODUCTS	N300 HALOGEN F0°	N300 HALOGEN F0° TP	N300 HALOGEN F5°	N300 HALOGEN F5° TP
<b>Bulb</b>	H3/H3 HD	H3/H3 HD	H3/H3 HD	H3/H3 HD
<b>Watt &amp; Voltage</b>	55W@12V   65W@24V HD Bulb   70W@24V	110W@12V   130W@24V HD Bulb   140W@24V	55W@12V   65W@24V HD Bulb   70W@24V	110W@12V   130W@24V HD Bulb   140W@24V
<b>Light Pattern</b>	Wide Flood	Wide Flood	Wide Flood	Wide Flood
<b>Mount</b>	Integrated	Integrated	Integrated	Integrated
<b>Vibration Dampening</b>	-	-	-	-



PRODUCTS	N100 HALOGEN F0°	N100 HALOGEN F0° TP	N100 HALOGEN F5°	N100 HALOGEN F5° TP
<b>Bulb</b>	H3/H3 HD	H3/H3 HD	H3/H3 HD	H3/H3 HD
<b>Watt &amp; Voltage</b>	55W@12V   65W@24V HD Bulb   70W@24V	110W@12V   130W@24V HD Bulb   140W@24V	55W@12V   65W@24V HD Bulb   70W@24V	110W@12V   130W@24V HD Bulb   140W@24V
<b>Light Pattern</b>	Wide Flood, Flood	Wide Flood, Flood	Wide Flood, Flood	Wide Flood, Flood
<b>Mount</b>	Integrated	Integrated	Integrated	Integrated
<b>Vibration Dampening</b>	-	-	-	-



## HALOGEN FLUSHMOUNT



PRODUCTS	N100 HALOGEN FB5°	N100 HALOGEN FB5° TP	N100 HALOGEN F27°	N100 HALOGEN F27° TP
<b>Bulb</b>	H3/H3 HD	H3/H3 HD	H3/H3 HD	H3/H3 HD
<b>Watt &amp; Voltage</b>	55W@12V   65W@24V HD Bulb   70W@24V	110W@12V   130W@24V HD Bulb   140W@24V	55W@12V   65W@24V HD Bulb   70W@24V	110W@12V   130W@24V HD Bulb   140W@24V
<b>Light Pattern</b>	Wide Flood	Wide Flood	Wide Flood	Wide Flood
<b>Mount</b>	Integrated	Integrated	Integrated	Integrated
<b>Vibration Dampening</b>	–	–	–	–

Connectors: AMP Terminal



PRODUCTS	N25 HALOGEN F0° TP	N25 HALOGEN FB12°		
<b>Bulb</b>	H3/H3 HD	H3/H3 HD		
<b>Watt &amp; Voltage</b>	110W@12V   130W@24V HD Bulb   140W@24V	55W@12V   65W@24V HD Bulb   70W@24V		
<b>Light Pattern</b>	Wide Flood, Flood, HighBeam, LowBeam	Wide Flood, Flood, HighBeam, LowBeam		
<b>Mount</b>	Integrated	Integrated		
<b>Vibration Dampening</b>	–	–		

Connectors: AMP Terminal, Pigtail Deutsch 2-pin



PRODUCTS	N400 HID BOOSTER XD	N400 HID XD	N400 HID BOOSTER XD HS	N200 HID XD
Bulb	D1S	D1S	D1S	D1S
Watt & Voltage	45W@12V   45W@24V	35W@12V   35W@24V	45W@12V   45W@24V	35W@12V   35W@24V
Light Pattern	Wide Flood, Flood, HighBeam, LowBeam	Wide Flood, Flood, HighBeam, LowBeam	Wide Flood, Flood, HighBeam, LowBeam	Wide Flood, Flood, HighBeam, LowBeam
Mount	M10	M10	M10	M10
Vibration Dampening	XD	XD	XD	XD



PRODUCTS	N45 HID BOOSTER XD	N45 HID XD	N45 HID BOOSTER	N45 HID
Bulb	D1S	D1S	D1S	D1S
Watt & Voltage	45W@12V   45W@24V	35W@12V   35W@24V	45W@12V   45W@24V	35W@12V   35W@24V
Light Pattern	Wide Flood, Flood, HighBeam, LowBeam	Wide Flood, Flood, HighBeam, LowBeam	Wide Flood, Flood, HighBeam, LowBeam	Wide Flood, Flood, HighBeam, LowBeam
Mount	M10	M10	M10	M10
Vibration Dampening	XD	XD	D	D



## HID WORK LIGHTS



### PRODUCTS

#### N45 HID BOOSTER H

#### N45 HID H

	N45 HID BOOSTER H	N45 HID H		
<b>Bulb</b>	45W D1S	35W D1S		
<b>Watt &amp; Voltage</b>	45W@12V   45W@24V	35W@12V   35W@24V		
<b>Light Pattern</b>	Wide Flood, Flood, HighBeam, LowBeam	Wide Flood, Flood, HighBeam, LowBeam		
<b>Mount</b>	M10	M10		
<b>Vibration Dampening</b>	D	D		

Connectors: Built-in Deutsch DT-2 (2-pin), Pigtail Deutsch 2-pin



## WARRANTY

For full details of warranty terms and conditions, please visit:

<http://www.nordiclights.com/upload/documents/GeneralTermsAndConditionsOfSaleAndDeliveryNordicLights.pdf>



## ABBREVIATIONS

D Dampening  
 ECE European Union Traffic Regulations  
 DS Down Side  
 F Flushmount  
 G Generation  
 H Handle  
 HS Handle & Switch  
 LH Left Hand mount

QD Quake Dampening  
 R Reverse  
 RH Right Hand mount  
 S Side mount  
 SAE USA Traffic Regulations  
 SD Super Dampening  
 SP Single Power  
 TD Suspended Pedestal mount (Top Down)

TP Twin Power  
 TT Upright Pedestal mount (Top Top)  
 US Up Side  
 V Version  
 XD Extreme Heavy Duty Dampening





 **NORDICLIGHTS**



**HEAD OFFICE**

Herrmans Oy Ab  
Bennäsvägen/Pännäistentie 143  
P.O. Box 36  
FIN-68601 Jakobstad/Pietarsaari  
Finland  
www.nordiclights.com  
Tel. +358 20 1345 100  
Fax +358 20 1345 108

**GERMANY**

Herrmans Nordic Lights GmbH  
Westfalendamm 241  
44141 Dortmund  
Germany  
Tel +49 231 948 692 610  
Fax +49 231 948 692 626

**USA**

Nordic Lights NA Inc  
4451 Robards Ln.  
Louisville, Kentucky 40218  
USA  
Tel +1 330 519 8133 / AM  
Tel +1 262 215 6930 / OEM

**BRAZIL**

Nordic Lights Brazil  
Rua Aiuruoca N:º 95, Apt 102B  
Belo Horizonte- Minas Gerais  
CEP 31.910-130  
Brazil  
Tel +55 31 9 9885-2564

**CHINA**

苏州拉普照明有限公司  
Nordic Lights (SuZhou) Co.,Ltd  
苏州工业园区葑亭大道598号2号厂房  
No.598 2# Fengting Avenue SIP Jiangsu  
China  
电话 0512-62535860, 0512-62535861  
Tel 0512-62535860, 0512-62535861  
传真 0512-62535862  
Fax 0512-62535862

**NORDICLIGHTS**









